

# KÄRCHER

makes a difference



**KÄRCHER**  
Professional

# PRESSURE WASHERS

Professional

# UNBEATABLE VERSATILITY - KÄRCHER PRESSURE WASHERS

As the inventor of the pressure washer, Kärcher is the world market leader in cleaning products. For more power with less consumption and shorter cleaning times, Kärcher pressure washers has the equipment that fulfills every cleaning need.



## Hot water (HDS)

Electric-powered, diesel heated Page 2-5  
Electric-powered, electric heated Page 6  
Electric-powered, NG/LP heated Page 7

## Cold water (HD)

Electric-powered Page 8-12

## Liberty hot water series

Electric-powered, diesel heated Page 14-15  
Electric-powered, NG/LP heated Page 16-18  
Electric-powered, electric heated Page 19  
Gas/diesel powered, diesel heated Page 20-22  
Hot water heater Page 23

## Liberty cold water series

Electric/gas-powered Page 24  
Electric-powered Page 24-27  
Gas/diesel-powered Page 28-34

## Trailer systems

Page 35-36

## Accessories

Page 37-80

## HDS UPRIGHT CLASS



### Mobility at its finest.

This high-performance, robust upright machine offers outstanding maneuverability, easy transport and intuitive operation. Ideal for tradesmen, commercial use and contract cleaners.



#### Technical Data

Model	Part No.	GPM	PSI	HP	Electrical	Amps	Pump	Weight (lbs.)	Dimensions (L x W x H) inches
HDS 1.7/12 U Ed	1.064-037.0	1.7	1200	2.3	110-120V / 1ph	12.5	Kärcher Axial	178	24 x 24 x 39

#### Standard Accessories

Product	Order No.	Description
Hose	6.391-342.0	High-pressure hose packaged
Trigger gun	4.775-529.0	Extended easy press trigger gun
Wand	4.760-665.0	550 mm lance, non-rotatable

#### Optional Accessories

Trigger gun	4.775-463.0	Easy press trigger gun with soft grip
Wand	2.642-305.0	Gutter cleaning lance
Wand	4.760-245.0	Underbody lance
Wand	9.112-508.0	21" with quick connect female threads
Wand	9.802-220.0	21" with quick connect male threads
Hose	6.389-479.0	High-pressure hose, 10m DN8, suitable for food industry, extension piece
Hose	6.390-028.0	Pipe cleaning hose
Hose	6.390-294.0	High-pressure hose Long-life 400, 30m DN8, including rotary coupling
Hose	8.739-132.0	100' hose, Tuff-Flex, 3/8" ID, 1-wire, 3000 psi, 275°
Surface cleaner	2.640-355.0	FR 30 ME surface cleaner
Surface cleaner	2.642-997.0	Surface cleaner FR 30
Wet blasting	4.762-010.0	Wet blasting attachment
Cleaning brush	4.762-560.0	Rotating washing brush natural fiber bristles
Cleaning brush	4.762-561.0	Rotating washing brush nylon bristles
Nozzles	2.638-526.0	Nozzle kit for wet blasting attachment
Nozzles	2.640-482.0	Nozzle kit for Surface cleaner FR
Nozzles	2.883-803.0	Power nozzle 25° spray angle
Nozzles	4.767-001.0	Triple nozzle, touchless changeover
Nozzles	4.767-022.0	Dirtblaster, small
Nozzles	4.767-230.0	Dirtblaster Nozzle 035
Detergent	3.637-170.0	Detergent injector for high pressure
Misc.	4.775-526.0	Servo-press Controller, Less than 3.3 GPM
Misc.	5.394-294.0	Spacer (incl. nozzle union)
Misc.	6.401-458.0	Quick coupling
Misc.	6.401-459.0	Plug nipple

# HDS COMPACT CLASS



## It's all in the detail.

Kärcher's German-built electric hot water machines are the most advanced on the market, featuring Kärcher's patented axial pump integrated with a 2-pole motor for optimum efficiency. Kärcher's efficient and compact downdraft-fired burner uses far less fuel than standard heat exchangers. Units come standard with low-fuel shut-off, low-water protection, high-temperature shut-off, thermal overload protection, soft-grip gun, and 50' hose. All units are ETL certified to UL and CSA standards.



### 1 Efficiency

- eco:efficiency mode – economical and environmentally friendly, even during longer periods of use.
- Reduces fuel consumption and CO<sup>2</sup> emissions by 20%.

### 2 Mobility

- Robust wheels and steering mechanism for maneuverability.
- Large integrated handles in the chassis.
- Integrated tilting aid for effortlessly negotiating obstacles such as steps and curbs.

## Technical Data

Model	Part No.	GPM	PSI	HP	Electrical	Amps	Pump	Weight (lbs.)	Dimensions (L x W x H) inches
HDS 2.3/12 C Ed	1.272-201.0	2.3	1100	2.8	110-120V/1ph	18.5	Kärcher Axial	270	42 x 26 x 36
HDS 3.0/20 C Ea	1.170-616.0	1.3-2.9	460-2000	5.6	220-240V/1ph	18.5	Kärcher Axial	285	42 x 26 x 36

## Accessories

Product	Order No.	Description
100' Pivot Hose Reel	8.750-685.0	100' Pivot Hose Reel, 3/8" x 100' with pin lock
Pivot hose reel bracket mount	8.921-775.0	*requires additional parts below
*Coupler	8.709-531.0	Coupler, Twist Seal, 3/8" Socket, Female
*Street Elbow	9.802-114.0	Street Elbow, 3/8" Mpt x 3/8" Fpt / 90 Degree
*Hose	8.918-280.0	Hose, 3/8" x 6'
Servo Control	4.775-526.0	Servo-press controller, less than 3.3 GPM

# HDS MID CLASS



## Jack of all trades.

The perfect hot water pressure washer for car dealers, building service contractors, agriculture and municipal use. The mid class machines set the standard in performance, ease of use, economy and service life.



### 1 Efficiency

- ecoefficiency mode – economical and environmentally friendly, even during longer periods of use.
- Reduces fuel consumption and CO<sup>2</sup> emissions by 20%.

### 2 Easy Press and Servo Control (optional accessory)

- The Easy Press trigger gun significantly reduces holding and operation effort, and the precise Servo Controller allows the user to adjust water flow rate and operating pressure directly from the trigger gun.

## Technical Data

Model	Part No.	GPM	PSI	HP	Electrical	Amps	Pump	Weight (lbs.)	Dimensions (L x W x H) inches
HDS 4.0/20-4M Ea	1.071-427.0	2.0-4.0	460-2000	8	220-240V / 1ph	28	Kärcher Axial	495	53 x 30 x 42
HDS 4.5/22-4M Ea	1.071-428.0	2.4-4.5	460-2250	9.5	220-240V / 1ph	30	Kärcher Axial	501	53 x 30 x 42
HDS 3.5/30-4M Ea	1.071-431.0	2.0-3.5	460-3000	9.5	220-240V / 1ph	30	Kärcher Axial	508	53 x 30 x 42
HDS 3.5/23-4M Eg	1.071-407.0	2.0-3.5	460-2300	8.1	200-208V / 1ph	30	Kärcher Axial	467	53 x 30 x 42

## Accessories

Product	Order No.	Description
100' Pivot Hose Reel	8.750-685.0	100' Pivot Hose Reel, 3/8" x 100' with pin lock
Pivot hose reel bracket mount	8.921-775.0	*requires additional parts below
*Coupler	8.709-531.0	Coupler, Twist Seal, 3/8" Socket, Female
*Street Elbow	9.802-114.0	Street Elbow, 3/8" Mpt x 3/8" Fpt / 90 Degree
*Hose	8.918-280.0	Hose, 3/8" x 6'
Servo Control	4.775-471.0	Servo-press Controller, 3.3 to 4.9 GPM

# HDS SUPER CLASS



## Full-size power.

Super class hot water pressure washers offer optimum cleaning performance, easy handling and the latest technology.



### 1 Service switch

- Service switch offers a choice of five settings to suit local water hardness. This allows optimum metered quantities of anti-scaler and corrosion inhibitor to be added to the water supply, and prevents the buildup of lime scale on the heater coil. Operating data can be called up any time, allowing you to make continual adjustments.

### 2 Time-proven burner technology with new turbo fan

- Kärcher burner technology not only translates to more economical operation, but also makes our hot water pressure washers trendsetters in environmental protection thanks to their low emissions and highly efficient operation.

## Technical Data

Model	Part No.	GPM	PSI	HP	Electrical	Amps	Pump	Weight (lbs.)	Dimensions (L x W x H) inches
HDS 5.0/30-4S Eb	1.071-625.0	2.4-5.0	460-3000	11	208-240V / 3ph	27	Kärcher Axial	507	53 x 30 x 42
HDS 5.0/30-4S Ec	1.071-626.0	2.4-5.0	460-3000	11	460-480V / 3ph	15	Kärcher Axial	511	53 x 30 x 42

## Accessories

Product	Order No.	Description
100' Pivot Hose Reel	8.750-685.0	100' Pivot Hose Reel, 3/8" x 100' with pin lock
Pivot hose reel bracket mount	8.921-775.0	*requires additional parts below
*Coupler	8.709-531.0	Coupler, Twist Seal, 3/8" Socket, Female
*Street Elbow	9.802-114.0	Street Elbow, 3/8" Mpt x 3/8" Fpt / 90 Degree
*Hose	8.918-280.0	Hose, 3/8" x 6'
Servo Control	4.775-471.0	Servo-press Controller, 3.3 to 4.9 GPM

## HDS SPECIAL CLASS



### The zero emission specialist.

The emission-free HDS-E 3.3/25-4M Ec with electric heater is ideal where exhaust gases are undesirable or prohibited. Thanks to the unique type of heater insulation and Kärcher eco!efficiency mode, the HDS-E 3.3/25-4M Ec is efficient and eco-friendly. Models are ETL certified to UL & CSA safety standards.



Shown with optional servo control.

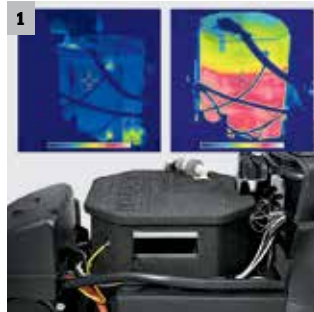

#### 1 Efficiency

- eco!efficiency mode – economical and environmentally friendly, even during longer periods of use.
- Reduces fuel consumption and CO<sup>2</sup> emissions by 20%.

#### 2 Ease of use

- Intuitive operation with large single-button selector switch.
- Easy fillable tanks for fuel and detergent.

### Technical Data

Model	Part No.	GPM	PSI	HP	Electrical	Amps	Pump	Weight (lbs.)	Dimensions (L x W x H) inches
HDS-E 3.3/25-4M Ec	1.030-252.0	1.6-3.3	465-2520	7.5	460V / 3ph	31	Kärcher Axial	350	51 x 32 x 45
HDS-E 3.3/25-4M Ef	1.030-253.0	1.6-3.3	465-2520	7.5	575V / 3ph	28	Kärcher Axial	352	51 x 32 x 45

### Accessories

Product	Order No.	Description
100' Pivot Hose Reel	8.750-685.0	100' Pivot Hose Reel, 3/8" x 100' with pin lock
Pivoting hose reel bracket mount	8.921-775.0	Classic pivoting hose reel bracket mount ( <b>*requires additional parts</b> )
* Hose	8.918-280.0	Hose, 3/8"x 6'
Caster wheel	6.435-777.0	Caster wheel, unlocked
Bolts	7.303-236.0	Bolts (requires 4)
Spacer sleeve	5.111-065.0	Spacer sleeve (requires 4)
* Coupler	8.709-531.0	Coupler, Twist Seal, 3/8" Socket, Female
* Street Elbow	9.802-114.0	Street Elbow, 3/8" Mpt x 3/8" Fpt / 90 Degree
Dirt blaster nozzle	9.302-444.0	Dirt blaster nozzle
Surface cleaner	2.640-355.0	Surface cleaner, FR 30 ME
Nozzle kit	2.639-187.0	Nozzle kit for FR
Coupler	4.403-002.0	Coupler
Servo Control	4.775-470.0	Servo Control

## HDS STATIONARY - NG / LP



### Innovation inside and out.

The innovative, rugged design of the new Kärcher Classic HDS natural gas and LP-heated cabinet pressure washer delivers up to 5 gpm at 3,000 psi of industrial power. Built in the U.S.A., each model is constructed with anodized structural rivets, a water cooled electric motor, standard auto start/stop and Kärcher's axial direct-drive pump backed by a 7-year warranty. All models are ETL certified to UL and CSA safety standards.



#### Features

- Kärcher Axial direct-drive pump with 7-year warranty
- Integrated RM 110 reservoir
- Built-in auto start/stop
- Steam stage
- Pulsation damper
- Kärcher Easy Press trigger gun
- Kärcher Power Nozzle
- "Stay-in-Place" ignition pilot light with swing out burner ring
- Cool wall cabinet construction

#### Technical Data

Natural Gas	Part No.	GPM	PSI	Electrical	Amps	Pump / RPM	HP	Weight (lbs.)	BTU	Dimensions (L x W x H)
HDS 3.5/23 Eg ST NG	1.109-797.0	3.5	2300	208V / 1ph	26	Kärcher Axial / 1725	8.1	695	310000	49 x 24 x 48
HDS 4.5/22 Ea ST NG	1.109-722.0	4.5	2200	230V / 1ph	30	Kärcher Axial / 1725	9.5	695	393000	49 x 24 x 48
HDS 3.5/30 Ea ST NG	1.109-729.0	3.5	3000	230V / 1ph	27	Kärcher Axial / 1725	9.5	695	310000	49 x 24 x 48
HDS 5.0/30 Eb ST NG	1.109-742.0	5	3000	230V / 1ph	27	Kärcher Axial / 1725	11	700	398000	49 x 24 x 48
HDS 5.0/30 Ec St NG	1.109-743.0	5	3000	460V / 1ph	19	Kärcher Axial / 1725	11	700	398000	49 x 24 x 48

#### LP gas-heated\*

HDS 3.5/23 Eg ST SP	1.109-798.0	3.5	2300	208V / 1ph	26	Kärcher Axial / 1725	8.1	695	310000	49 x 24 x 48
HDS 4.5/22 Ea ST LP	1.109-763.0	4.5	2200	230V / 1ph	30	Kärcher Axial / 1725	9.5	695	393000	49 x 24 x 48
HDS 3.5/30 Ea ST LP	1.109-770.0	3.5	3000	230V / 1ph	27	Kärcher Axial / 1725	9.5	695	310000	49 x 24 x 48
HDS 5.0/30 Eb ST LP	1.109-783.0	5	3000	230V / 1ph	27	Kärcher Axial / 1725	11	700	398000	49 x 24 x 48
HDS 5.0/30 Ec St LP	1.109-784.0	5	3000	460V / 1ph	19	Kärcher Axial / 1725	11	700	398000	49 x 24 x 48

\*Propane regulator and power cord sold separately

#### Accessories - Simple to configure with "Easy-Add" option kits

Product	Order No.
Remote Kit single station	2.744-008.0
Chemical solenoid valve (brass) for use with remote kit	6.685-195.0
Chemical solenoid valve (stainless steel) for use with remote kit	8.708-846.0
Draft diverter, 10"	9.801-040.0
Damper, draft 10"	8.753-474.0
Easy press trigger gun with soft grip	4.775-466.0
Kärcher Tuff-Flex, 1-wire, 3/8" ID, 50', 3000 PSI, 275°	8.739-130.0
Self-winding hose reel, 66'	2.639-919.0
Swivel wall mount bracket	2.639-931.0
Hot Water Discharge Outlet Relocation	8.923-213.0



# HD COMPACT CLASS



## Designed to move.

The HD 1.8/13 C compact cold water pressure washer offers maximum portability, maneuverability and smart features. It can be stored, transported and operated in the vertical and horizontal position, and at 55.6 lbs, this professionally built unit can easily be moved by one person in and out of vehicles and around a cleaning site. It also includes storage options for accessories, and is certified to UL and CSA safety standards.

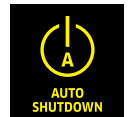

### Technical Data

Model	Part No.	GPM	PSI	Electrical	Amps	Pump	Weight (lbs.)	Dimensions (L x W x H) inches
HD 1.8/13 C	1.520-149.0	1.8	1300	120V / 1ph ~ / 60 Hz	14	Kärcher Axial	56	15 x 14 x 37

### Accessories

Product	Order No.	Description
Trigger gun	4.775-463.0	Easy Press trigger gun
Spray wand	4.760-663.0	Turnable stainless steel spray lance 33"
Hose	6.391-238.0	High-pressure hose 33'
Nozzle	4.767-195.0	Triple nozzle 032

### Optional Accessories

Inno Foam kit	2.640-151.0	Inno Foam kit
Easy Foam kit	2.640-691.0	Easy Foam kit
Bottle foam lance	6.394-668.0	Bottle foam lance
Flexible spray lance	6.394-654.0	Flexible spray lance
Hose	6.391-238.0	High-pressure hose 33'
Extension hose	4.440-939.0	Extension hose for FRV 30
Pipe cleaning hose	6.390-028.0	Pipe cleaning hose 65', 1740 psi
Pipe cleaning hose	6.390-029.0	Pipe cleaning hose 98', 1740 psi
Pipe cleaning hose	6.390-030.0	Pipe cleaning hose 65', 3625 psi
Washing brush	4.762-497.0	Washing brush
Rotating washing brush	4.762-561.0	Rotating washing brush nylon bristles
Rotating washing brush	4.762-560.0	Rotating washing brush natural fiber bristles
Surface cleaner	2.642-997.0	Surface cleaner FR 30
Surface cleaner	2.642-998.0	Surface cleaner FR Basic
Surface cleaner	2.642-999.0	Surface cleaner FRV 30
Wet blasting attachment	4.762-022.0	Wet blasting attachment
Nozzle kit	2.640-482.0	Nozzle kit for Surface cleaner FR
Nozzle kit	2.642-430.0	Nozzle kit for FRV 30
Nozzle kit	2.640-870.0	Nozzle kit
Nozzle connector	4.402-022.0	Nozzle connector
Nozzle kit for wet blasting attachment	2.638-526.0	Nozzle kit for wet blasting attachment
Coupling	4.403-002.0	Coupling
Quick-release coupling	6.401-458.0	Quick-release coupling
Nipple	6.401-459.0	Nipple

## HD COMPACT CLASS



### The compact class – fast and thorough.

These reliable, compact all-rounders offer the benefits of low weight, compact dimensions, easy handling and high cleaning performance. Ideal for workshops, courtyards, etc.

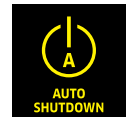

#### Technical Data

Model	Part No.	GPM	PSI	Electrical	Amps	Pump	Weight (lbs.)	Dimensions (L x W x H) inches
HD 2.3/15 C Ed	1.150-626.0	2.3	1500	120V / 1ph	20	Kärcher Axial	71	15 x 15 x 37
HD 3.0/20 C Ea	1.150-625.0	3	2000	240V / 1ph	20	Kärcher Axial	71	15 x 15 x 37

#### Standard Accessories

Product	Order No.	Description
Trigger gun	4.775-463.0	Easy Press trigger gun
Spray wand	4.760-663.0	Turnable stainless steel spray lance 33"
Hose	6.391-238.0	High-pressure hose 33'
Nozzle	4.767-195.0	Triple nozzle 032

#### Optional Accessories

Inno Foam kit	2.640-151.0	Inno Foam kit
Easy Foam kit	2.640-691.0	Easy Foam kit
Bottle foam lance	6.394-668.0	Bottle foam lance
Flexible spray lance	6.394-654.0	Flexible spray lance
Hose	6.391-238.0	High-pressure hose 33'
Extension hose	4.440-939.0	Extension hose for FRV 30
Pipe cleaning hose	6.390-028.0	Pipe cleaning hose 65', 1740 psi
Pipe cleaning hose	6.390-029.0	Pipe cleaning hose 98', 1740 psi
Pipe cleaning hose	6.390-030.0	Pipe cleaning hose 65', 3625 psi
Washing brush	4.762-497.0	Washing brush
Rotating washing brush	4.762-561.0	Rotating washing brush nylon bristles
Rotating washing brush	4.762-560.0	Rotating washing brush natural fiber bristles
Surface cleaner	2.642-997.0	Surface cleaner FR 30
Surface cleaner	2.642-998.0	Surface cleaner FR Basic
Surface cleaner	2.642-999.0	Surface cleaner FRV 30
Wet blasting attachment	4.762-022.0	Wet blasting attachment
Nozzle kit	2.640-482.0	Nozzle kit for Surface cleaner FR
Nozzle kit	2.642-430.0	Nozzle kit for FRV 30
Nozzle kit	2.640-870.0	Nozzle kit
Nozzle connector	4.402-022.0	Nozzle connector
Nozzle kit for wet blasting attachment	2.638-526.0	Nozzle kit for wet blasting attachment
Coupling	4.403-002.0	Coupling
Quick-release coupling	6.401-458.0	Quick-release coupling
Nipple	6.401-459.0	Nipple

## HD MID CLASS



### Loaded with features.

This medium class machine is extremely mobile and user-friendly with low-speed four-pole single phase motor for continuous use.



#### Technical Data

Model	Part No.	GPM	PSI	HP	Electrical	Amps	Pump	Weight (lbs.)	Dimensions (L x W x H) inches
HD 3.0/20-4M Ea	1.524-126.0	1.3-3.0	435-2000	4.7	220-240V / 1ph	18	Kärcher Axial	105	22 x 20 x 40

#### Accessories

Product	Order No.	Description
Trigger gun	4.775-463.0	Easy press trigger gun with soft-grip
Wand	4.760-660.0	1050 mm lance, rotatable, ergonomic
Hose	6.391-238.0	High-pressure hose, 10m DN6, AVS trigger gun connector
Nozzle	4.767-065.0	Triple nozzle, touchless changeover
Servo	4.775-526.0	Servo Control

#### Optional Accessories

Gun	4.775-466.0	Easy press high-pressure trigger gun with soft-grip
Inno Foam kit	2.640-151.0	Inno Foam kit with detergent injector
Easy Foam kit	2.640-691.0	Easy Foam kit
Wand	4.760-230.0	1040 mm variable pressure lance
Bottle foam lance	6.394-668.0	Bottle foam lance
Hose	8.739-132.0	100' hose, Tuff-Flex, 3/8" ID, 1-wire, 3000 psi, 275°
Surface cleaner	2.640-355.0	FR 30 ME surface cleaner
Surface cleaner	2.640-679.0	FR 50 hard surface cleaner
Surface cleaner	2.642-997.0	Surface cleaner FR 30
Surface cleaner	2.642-998.0	Surface cleaner FR Basic
Surface cleaner	2.642-999.0	FRV 30 hard surface cleaner
Wet blasting attachment	4.762-010.0	Wet blasting attachment
Wet blasting attachment	4.762-022.0	Wet blasting attachment
Washing brush	4.762-497.0	Washing brush
Nozzle kit for wet blasting attachment	2.638-526.0	Nozzle kit for wet blasting attachment
Nozzle kit for Surface cleaner FR	2.639-187.0	Nozzle kit for Surface cleaner FR
Nozzle kit	2.640-482.0	Nozzle kit for Surface cleaner FR
Nozzle kit	2.640-870.0	Nozzle kit
Nozzle kit	2.642-430.0	Nozzle kit for FRV 30
Nozzle	2.884-522.0	Power nozzle 40° spray angle
Dirt Blaster	4.767-023.0	Dirt blaster nozzle, small

# HD SUPER CLASS

## For tough jobs in non-stop use.

Where vast amounts of dirt accumulate every day, reliable Kärcher super class models provide indispensable services. Ideal for use in the construction, agricultural and forestry sectors as well as industrial and municipal facilities.



### Technical Data

Model	Part No.	GPM	PSI	HP	Electrical	Amps	Pump	Weight (lbs.)	Dimensions (L x W x H) inches
HD 3.5/30-4S Ea	1.286-127.0	1.8-3.5	435-3000	9	220/240V / 1ph	28	Kärcher Axial	178	22 x 20 x 43
HD 4.5/32-4S Eb	1.286-128.0	2.2-4.5	435-3200	10	230V / 1ph	25	Kärcher Axial	178	22 x 20 x 43
HD 4.5/32-4S Ec	1.286-129.0	2.2-4.5	435-3200	10	460V / 3ph	14	Kärcher Axial	178	22 x 20 x 43

### Accessories

Product	Order No.	Description
Hose	6.390-010.0	15m high-pressure hose
Trigger gun	4.775-466.0	Easy press high-pressure trigger gun with soft-grip
Servo	4.775-471.0	Servo Control
Nozzle	4.767-002.0	Triple nozzle, touchless changeover
Wand	4.760-660.0	1050 mm lance, rotatable, ergonomic

### Optional Accessories

Gun	4.775-463.0	Easy press trigger gun with soft grip
Inno Foam kit	2.640-151.0	Inno Foam kit
Wand	2.642-305.0	Gutter cleaning lance
Flexible spray lance	6.394-654.0	Flexible spray lance
Bottle foam lance	6.394-668.0	Bottle foam lance
Extension hose	4.440-939.0	Extension hose for FRV 30
Extension hose	4.441-040.0	Suction hose for FRV 30 ME
Pipe cleaning hose	6.390-028.0	Pipe cleaning hose 65', 1740 psi
Pipe cleaning hose	6.390-029.0	Pipe cleaning hose 98', 1740 psi
Pipe cleaning hose	6.390-030.0	Pipe cleaning hose 65', 3625 psi
Surface cleaner	2.640-679.0	FR 50 hard surface cleaner
Surface cleaner	2.642-911.0	FRV 30 ME
Surface cleaner	2.642-997.0	Surface cleaner FR 30
Surface cleaner	2.642-999.0	FRV 30 hard surface cleaner
Wet blasting attachment	4.762-010.0	Wet blasting attachment
Nozzle kit	2.640-482.0	Nozzle kit for Surface cleaner FR
Nozzle kit 050 - for FRV 30	2.642-433.0	Nozzle kit 050 - for FRV 30
Nozzle	2.884-521.0	25° power nozzle for applying cleaning agent
Nozzle	4.767-230.0	Dirtblaster Nozzle 035
Injector	3.637-170.0	Detergent injector for high pressure
Coupling	4.403-002.0	Coupling

## HD SPECIAL CLASS



### For strict hygiene requirements.

Cold water high-pressure cleaner for all-purpose industrial use in the sanitary/food industry. This top-of-the-range machine from the compact class allows you to regulate pressure and water flow seamlessly.



#### 1 Convenient Easy Press

- Ergonomic design for convenient operation.
- Reduced exhaust and retention force for effortless operation.
- Soft grip surface for a secure grip.

#### 2 High standard of hygiene

- Food-safe, non-marking high-pressure hose.
- Wear-resistant and non-marking gray wheels.
- Accepts inlet water at temperatures up to 180°F.

#### 3 Practical detergent system

- Cleaning agent intake system for removing stubborn dirt.
- The "Inno Foam Set" high-pressure foam system can be used.

#### 4 Variable pressure and water flow regulation

- Easy access on the machine.
- Gentle cleaning of sensitive surfaces.

### Technical Data

Model	Part No.	GPM	PSI	HP	Electrical	Amps	Pump	Weight (lbs.)	Dimensions (L x W x H) inches
HD 2.3/14 C Ed Food	1.150-629.0	2.3	1400	3.2	120V / 1ph	20	Kärcher Axial	71	15 x 15 x 37

## **RUGGED, BUILT FOR IT ALL - KÄRCHER LIBERTY SERIES**

As the inventor of the pressure washer, Kärcher is the world market leader in cleaning products. For more power with less consumption and shorter cleaning times, Kärcher pressure washers has the equipment that fulfills every cleaning need.



# LIBERTY HDS HAND TRUCK



## Heavy-duty output.

Kärcher offers four North American designed models with their unique hand truck design, all-metal frame and heavy-duty vertical heating coil with stainless steel wrap. Units come with belt-drive Kärcher crankcase pumps. All are ETL certified to UL and CSA safety standards.



### Durable design

- Industrial-grade motor with two-year warranty.
- High-output burner with transformer for years of reliable and affordable operation.
- Industrial-grade, tri-plunger, oil-bath, Kärcher pump with 7-year warranty.
- Heavy-gauge 11/4" steel frame with powder coat finish for all-weather protection.
- Insulated Schedule 80 heating coil is made of 1/2-inch steel pipe and cold-rolled; comes standard with stainless steel coil wrap and 5-year warranty.

### Smart features

- Cast iron pulley system with OSHA-compliant, totally enclosed belt guard, and easy-to-adjust belt tension (belt-drive models).
- Water resistant control box with burner on/off switch and adjustable thermostat.
- 50 ft. of wire braided hose with burst guard for added protection.
- High pressure rupture disc rated to 7000 lbs to protect user against injury.
- Options are auto start/stop or time delay shutdown, float tank, steam combination.

### Technical Data

Model	Part No.	GPM	PSI	HP	Electrical	Amps	Pump	Weight (lbs.)	Dimensions (L x W x H) inches
HDS 3.9/20 Ea	1.575-505.0	3.9	2000	6	230V / 1ph	29	Kärcher KM	660	49 x 40 x 50
HDS 3.5/30 Ea	1.575-508.0	3.5	3000	7.5	230V / 1ph	36	Kärcher KM	690	49 x 40 x 50
HDS 3.5/30 Eb	1.575-509.0	3.5	3000	7.5	230V / 3ph	25	Kärcher KM	605	49 x 40 x 50
HDS 3.5/30 Ec	1.575-510.0	3.5	3000	7.5	460V / 3ph	13	Kärcher KM	605	49 x 40 x 50

### Options (factory installed)

Product	Order No.	Description
Float tank	9.801-008.0	Float tank (6-7.5 HP units, with soap valve)
Auto start/stop	9.801-006.0	Auto start/stop (6-7.5 HP models)
Auto start/stop and steam combo	9.804-512.0	Auto start/stop and steam combo (6-7.5 HP models)
Auto start/stop and float tank	9.804-513.0	Auto start/stop and float tank (6-7.5 HP models)
Auto start/stop, steam and float tank	9.804-514.0	Auto start/stop, steam and float tank (6-7.5 HP models)
Steam combination	9.804-515.0	Steam combination (6-7 HP, with float tank)
Steam combination	9.801-009.0	Steam combination (6-7 HP, without float tank)
Time delay	9.801-001.0	Time delay

**Time delay shutdown and auto start/stop are mutually exclusive**

### Options (field installed)

Product	Order No.	Description
Extended Soft-grip Trigger Gun	4.775-529.0	Extended Soft-grip Trigger Gun, ID 6, Integrated AVS hose connection
Hose	8.739-132.0	Kärcher Tuff-Flex, 1-wire, 3/8" ID, 100', 3000 PSI, 275°
100' EZEE Hose Reel Kit	9.801-023.0	100' EZEE hose reel kit (hose not included)

## LIBERTY HDS CAGE



### Rugged operations.

Built on a rugged 1-1/4" powder coated steel frame, these compact electric roll cage models are designed for construction sites, farms and factories where electricity is available. The three models deliver hot water cleaning of up to 2000 PSI using 120V or 230V/1ph. Each features a Kärcher direct-drive crankcase-style pump with limited 7-year warranty, industrial-grade motor, flat-free tires and 1/2" Schedule 80 heating coil with stainless steel wrap. All are certified to UL and CSA safety standards.



#### Durable design

- Industrial-grade motors provide reliable power to the pump.
- Industrial-grade, tri-plunger, oil-bath, direct-drive, Kärcher pump with 7-year warranty.
- 50 ft. of durable, wire braid hose rated for 3000 PSI and with hose guard for burst.
- Safety relief valve attached to discharge side for protection against excess pressure build up.
- Insulated Schedule 80 heating coil is made of 1/2-inch steel pipe and cold-rolled; comes standard with stainless steel coil wrap.

#### Smart features

- Easy-to-attach downstream detergent injection with quick couplers and brass soap nozzle.
- Fuel filter/water separator ensures pure fuel supply.
- Insulated, high-pressure trigger gun for hours of fatigue-free cleaning.

#### Technical Data

Model	Part No.	GPM	PSI	HP	Electrical	Amps	Pump	Weight (lbs.)	Dimensions (L x W x H) inches
HDS 2.0/10 Ed Cage	1.575-511.0	2.1	1000	1.5	120V / 1ph	15	Kärcher KE	480	39 x 27 x 44
HDS 1.9/15 Ed Cage	1.575-512.0	1.9	1500	2	120V / 1ph	20	Kärcher KE	480	39 x 27 x 44
HDS 3.5/20 Ea Cage	1.575-513.0	3.5	2000	5	230V / 1ph	22	Kärcher KE	500	39 x 27 x 44

#### Options (factory installed)

Product	Order No.	Description
100' EZEE Hose Reel Kit	9.801-024.0	100' EZEE hose reel kit (hose not included)
100' Pivot Hose Reel Kit	9.804-570.0	100' Pivot hose reel kit (hose not included)



# LIBERTY HDS STATIONARY - NG/LP



## High cleaning performance.

The Liberty Kärcher HDS natural gas and LP-heated cabinet pressure washer delivers up to 9.5 gpm at 3000 psi of industrial power. Built in the U.S.A., each model is constructed with anodized structural rivets, industrial motors and Kärcher pumps that are backed by a 7-year warranty. All models are ETL certified to UL and CSA safety standards.

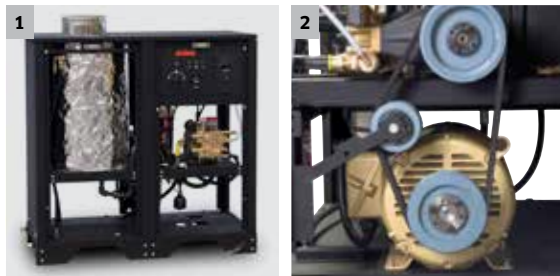

### 1 Easy to service and operate

- All-access cabinet design with six lift out panels and easy lock fasteners provides easy access to components for maintenance in tight situations.
- Swing-out cast iron burner ring with separate “stay-in-place” ignition pilot light allows easy access and removal of the burner ring.

### 2 Smart Engineering

- Improved “Stay-Tite” belt tensioning system maintains belt tension on the pump with a torsion bar for precise tension adjustment.
- The heating coil is made of leak-free, cold rolled, schedule 80 steel pipe and is wrapped with a thick foil blanket insulation that keeps cabinet walls cool to the touch.

### Accessories - Simple to configure with “Easy-Add” option kits

Product	Order No.
Kit, time delay shutdown	8.917-508.0
Kit, wireless remote pump/burner/detergent	8.917-509.0
Wireless hand-held transmitter	8.921-832.0
Kit, wall bracket wireless transmitter	8.917-817.0
NG kit, wired remote station - pump and burner	8.921-774.0
NG kit, wired remote detergent	8.921-773.0
Remote control box (wired)	8.922-157.0
Kit, auto start/stop - wireless remote, no remote	8.917-507.0
Kit, auto start/stop - wired remote, no lockout	9.807-646.0
Kit, steam combo	8.921-776.0
Draft diverter, 10", up to 5 gpm	9.801-040.0
Draft diverter, 12", over 5 gpm	8.717-730.0
Draft damper, 10"	8.753-474.0
Draft damper, 12"	8.753-478.0
Reducer, stack 12" to 10"	8.753-706.0
Reducer, stack 10" to 8"	8.753-707.0
Outlet relocater	8.923-213.0

## HDS STATIONARY - NG/LP

### Natural gas-heated 3.5-5 GPM medium cabinet design

Model	Part No.	GPM	PSI	Electrical	Amps	Pump / RPM	HP	Weight (lbs.)	BTU	Dimensions (L x W x H)
HDS 3.5/20 Ea ST NG	1.109-715.0	3.5	2000	230V / 1ph	25	KD4020R / 1350	5	815	320,000	49 x 24 x 48
HDS 4.0/22 Ea ST NG	1.109-716.0	4	2200	230V / 1ph	29	KM4035R / 1250	6.2	843	364,000	49 x 24 x 48
HDS 4.0/22 Eb ST NG	1.109-717.0	4	2200	230V / 3ph	16	KM4035R / 1250	6.2	843	364,000	49 x 24 x 48
HDS 4.0/22 Ec ST NG	1.109-718.0	4	2200	460V / 3ph	7	KM4035R / 1250	6.2	843	364,000	49 x 24 x 48
HDS 4.0/22 Ef ST NG	1.109-719.0	4	2200	575V / 3ph	6.5	KM4035R / 1250	6.2	843	364,000	49 x 24 x 48
HDS 4.0/22 Eg ST NG	1.109-720.0	4	2200	208V / 1ph	30	KM4035R / 1250	6.2	843	364,000	49 x 24 x 48
HDS 4.0/22 Eh ST NG	1.109-721.0	4	2200	208V / 3ph	18	KM4035R / 1250	6.2	843	364,000	49 x 24 x 48
HDS 3.9/30 Ea ST NG	1.109-723.0	3.9	3000	230V / 1ph	36	KM4035R / 1225	8.2	856	354,000	49 x 24 x 48
HDS 3.9/30 Eb ST NG	1.109-724.0	3.9	3000	230V / 3ph	25	KM4035R / 1225	8.2	856	354,000	49 x 24 x 48
HDS 3.9/30 Ec ST NG	1.109-725.0	3.9	3000	460V / 3ph	15	KM4035R / 1225	8.2	856	354,000	49 x 24 x 48
HDS 3.9/30 Ef ST NG	1.109-726.0	3.9	3000	575V / 3ph	14	KM4035R / 1225	8.2	856	354,000	49 x 24 x 48
HDS 3.9/30 Eg ST NG	1.109-727.0	3.9	3000	208V / 1ph	38	KM4035R / 1225	8.2	856	354,000	49 x 24 x 48
HDS 3.9/30 Eh ST NG	1.109-728.0	3.9	3000	208V / 3ph	27	KM4035R / 1225	8.2	856	354,000	49 x 24 x 48
HDS 4.8/30 Ea ST NG	1.109-736.0	4.8	3000	230V / 1ph	40	KT6035R / 1225	10	885	415,000	49 x 24 x 48
HDS 4.8/30 Eb ST NG	1.109-737.0	4.8	3000	230V / 3ph	26	KT6035R / 1225	10	885	415,000	49 x 24 x 48
HDS 4.8/30 Ec ST NG	1.109-738.0	4.8	3000	460V / 3ph	15	KT6035R / 1225	10	885	415,000	49 x 24 x 48
HDS 4.8/30 Ef ST NG	1.109-739.0	4.8	3000	575V / 3ph	14	KT6035R / 1225	10	885	415,000	49 x 24 x 48
HDS 4.8/30 Eg ST NG	1.109-740.0	4.8	3000	208V / 1ph	49	KT6035R / 1225	10	885	415,000	49 x 24 x 48
HDS 4.8/30 Eh ST NG	1.109-741.0	4.8	3000	208V / 3ph	32	KT6035R / 1225	10	885	415,000	49 x 24 x 48
HDS 5.0/23 Ea ST NG	1.109-730.0	5.0	2300	230V / 1ph	36	KT6035R / 1225	8.2	856	439,000	49 x 24 x 48
HDS 5.0/23 Eb ST NG	1.109-731.0	5.0	2300	230V / 3ph	25	KT6035R / 1225	8.2	856	439,000	49 x 24 x 48
HDS 5.0/23 Ec ST NG	1.109-732.0	5.0	2300	460V / 3ph	15	KT6035R / 1225	8.2	856	439,000	49 x 24 x 48
HDS 5.0/23 Ef ST NG	1.109-733.0	5.0	2300	575V / 3ph	14	KT6035R / 1225	8.2	856	439,000	49 x 24 x 48
HDS 5.0/23 Eg ST NG	1.109-734.0	5.0	2300	208V / 1ph	38	KT6035R / 1225	8.2	856	439,000	49 x 24 x 48
HDS 5.0/23 Eh ST NG	1.109-735.0	5.0	2300	208V / 3ph	27	KT6035R / 1225	8.2	856	439,000	49 x 24 x 48

### Natural gas-heated 6.3+ GPM large cabinet design

Model	Part No.	GPM	PSI	Electrical	Amps	Pump / RPM	HP	Weight (lbs.)	BTU	Dimensions (L x W x H)
HDS 6.3/32 Eb ST NG	1.109-744.0	6.3	3200	230V / 3ph	39	KT6035R / 1625	15	1825	507,000	64 x 35 x 61
HDS 6.3/32 Ec ST NG	1.109-745.0	6.3	3200	460V / 3ph	19	KT6035R / 1625	15	1825	507,000	64 x 35 x 61
HDS 6.3/32 Ef ST NG	1.109-746.0	6.3	3200	575V / 3ph	18	KT6035R / 1625	15	1825	507,000	64 x 35 x 61
HDS 6.3/32 Eh ST NG	1.109-747.0	6.3	3200	208V / 3ph	39	KT6035R / 1625	15	1825	507,000	64 x 35 x 61
HDS 8.0/32 Eb ST NG	1.109-748.0	8.0	3200	230V / 3ph	46	KX9536R / 1458	20	1840	658,000	64 x 35 x 61
HDS 8.0/32 Ec ST NG	1.109-749.0	8.0	3200	460V / 3ph	26	KX9536R / 1458	20	1840	658,000	64 x 35 x 61
HDS 8.0/32 Ef ST NG	1.109-750.0	8.0	3200	575V / 3ph	26	KX9536R / 1458	20	1840	658,000	64 x 35 x 61
HDS 8.0/32 Eh ST NG	1.109-751.0	8.0	3200	208V / 3ph	52	KX9536R / 1458	20	1840	658,000	64 x 35 x 61
HDS 9.5/30 Eb ST NG	1.109-752.0	9.5	3000	230V / 3ph	52	KX1036R / 1650	20	1910	816,000	64 x 35 x 61
HDS 9.5/30 Ec ST NG	1.109-753.0	9.5	3000	460V / 3ph	26	KX1036R / 1650	20	1910	816,000	64 x 35 x 61
HDS 9.5/30 Ef ST NG	1.109-754.0	9.5	3000	575V / 3ph	26	KX1036R / 1650	20	1910	816,000	64 x 35 x 61
HDS 9.5/30 Eh ST NG	1.109-755.0	9.5	3000	208V / 3ph	52	KX1036R / 1650	20	1910	816,000	64 x 35 x 61

## HDS STATIONARY - LP

### LP gas-heated 3.5-5 GPM medium cabinet design\*

Model	Part No.	GPM	PSI	Electrical	Amps	Pump / RPM	HP	Weight (lbs.)	BTU	Dimensions (L x W x H)
HDS 3.5/20 Ea ST LP	1.109-756.0	3.5	2000	230V / 1ph	25	KD4020R / 1350h	5	815	320,000	49 x 24 x 48
HDS 4.0/22 Ea ST LP	1.109-757.0	4	2200	230V / 1ph	29	KM4035R / 1250	6.2	843	364,000	49 x 24 x 48
HDS 4.0/22 Eb ST LP	1.109-758.0	4	2200	230V / 3ph	16	KM4035R / 1250	6.2	843	364,000	49 x 24 x 48
HDS 4.0/22 Ec ST LP	1.109-759.0	4	2200	460V / 3ph	7	KM4035R / 1250	6.2	843	364,000	49 x 24 x 48
HDS 4.0/22 Ef ST LP	1.109-760.0	4	2200	575V / 3ph	6.5	KM4035R / 1250	6.2	843	364,000	49 x 24 x 48
HDS 4.0/22 Eg ST LP	1.109-761.0	4	2200	208V / 1ph	30	KM4035R / 1250	6.2	843	364,000	49 x 24 x 48
HDS 4.0/22 Eh ST LP	1.109-762.0	4	2200	208V / 3ph	18	KM4035R / 1250	6.2	843	364,000	49 x 24 x 48
HDS 3.9/30 Ea ST LP	1.109-764.0	3.9	3000	230V / 1ph	36	KM4035R / 1225	8.2	856	354,000	49 x 24 x 48
HDS 3.9/30 Eb ST LP	1.109-765.0	3.9	3000	230V / 3ph	25	KM4035R / 1225	8.2	856	354,000	49 x 24 x 48
HDS 3.9/30 Ec ST LP	1.109-766.0	3.9	3000	460V / 3ph	15	KM4035R / 1225	8.2	856	354,000	49 x 24 x 48
HDS 3.9/30 Ef ST LP	1.109-767.0	3.9	3000	575V / 3ph	14	KM4035R / 1225	8.2	856	354,000	49 x 24 x 48
HDS 3.9/30 Eg ST LP	1.109-768.0	3.9	3000	208V / 1ph	38	KM4035R / 1225	8.2	856	354,000	49 x 24 x 48
HDS 3.9/30 Eh ST LP	1.109-769.0	3.9	3000	208V / 3ph	27	KM4035R / 1225	8.2	856	354,000	49 x 24 x 48
HDS 4.8/30 Ea ST LP	1.109-777.0	4.8	3000	230V / 1ph	40	KT6035R / 1225	10	885	415,000	49 x 24 x 48
HDS 4.8/30 Eb ST LP	1.109-778.0	4.8	3000	230V / 3ph	26	KT6035R / 1225	10	885	415,000	49 x 24 x 48
HDS 4.8/30 Ec ST LP	1.109-779.0	4.8	3000	460V / 3ph	15	KT6035R / 1225	10	885	415,000	49 x 24 x 48
HDS 4.8/30 Ef ST LP	1.109-780.0	4.8	3000	575V / 3ph	14	KT6035R / 1225	10	885	415,000	49 x 24 x 48
HDS 4.8/30 Eg ST LP	1.109-781.0	4.8	3000	208V / 1ph	49	KT6035R / 1225	10	885	415,000	49 x 24 x 48
HDS 4.8/30 Eh ST LP	1.109-782.0	4.8	3000	208V / 3ph	32	KT6035R / 1225	10	885	415,000	49 x 24 x 48
HDS 5.0/23 Ea ST LP	1.109-771.0	5.0	2300	230V / 1ph	36	KT6035R / 1225	8.2	856	439,000	49 x 24 x 48
HDS 5.0/23 Eb ST LP	1.109-772.0	5.0	2300	230V / 3ph	25	KT6035R / 1225	8.2	856	439,000	49 x 24 x 48
HDS 5.0/23 Ec ST LP	1.109-773.0	5.0	2300	460V / 3ph	15	KT6035R / 1225	8.2	856	439,000	49 x 24 x 48
HDS 5.0/23 Ef ST LP	1.109-774.0	5.0	2300	575V / 3ph	14	KT6035R / 1225	8.2	856	439,000	49 x 24 x 48
HDS 5.0/22 Eg ST LP	1.109-775.0	5.0	2200	208V / 1ph	38	KT6035R / 1225	8.2	856	439,000	49 x 24 x 48
HDS 5.0/23 Eh ST LP	1.109-776.0	5.0	2300	208V / 3ph	27	KT6035R / 1225	8.2	856	439,000	49 x 24 x 48

\*Propane regulator and power cord sold separately

### LP gas-heated 6.3+ GPM large cabinet design\*

Model	Part No.	GPM	PSI	Electrical	Amps	Pump / RPM	HP	Weight (lbs.)	BTU	Dimensions (L x W x H)
HDS 6.3/32 Eb ST LP	1.109-785.0	6.3	3200	230V / 3ph	39	KT6035R / 1625	15	1825	507,000	64 x 35 x 61
HDS 6.3/32 Ec ST LP	1.109-786.0	6.3	3200	460V / 3ph	19	KT6035R / 1625	15	1825	507,000	64 x 35 x 61
HDS 6.3/32 Ef ST LP	1.109-787.0	6.3	3200	575V / 3ph	18	KT6035R / 1625	15	1825	507,000	64 x 35 x 61
HDS 6.3/32 Eh ST LP	1.109-788.0	6.3	3200	208V / 3ph	39	KT6035R / 1625	15	1825	507,000	64 x 35 x 61
HDS 8.0/32 Eb ST LP	1.109-789.0	8.0	3200	230V / 3ph	46	KX9536R / 1458	20	1840	658,000	64 x 35 x 61
HDS 8.0/32 Ec ST LP	1.109-790.0	8.0	3200	460V / 3ph	26	KX9536R / 1458	20	1840	658,000	64 x 35 x 61
HDS 8.0/32 Ef ST LP	1.109-791.0	8.0	3200	575V / 3ph	26	KX9536R / 1458	20	1840	658,000	64 x 35 x 61
HDS 8.0/32 Eh ST LP	1.109-792.0	8.0	3200	208V / 3ph	52	KX9536R / 1458	20	1840	658,000	64 x 35 x 61
HDS 9.5/30 Eb ST LP	1.109-793.0	9.5	3000	230V / 3ph	52	KX1036R / 1650	20	1910	775,000	64 x 35 x 61
HDS 9.5/30 Ec ST LP	1.109-794.0	9.5	3000	460V / 3ph	26	KX1036R / 1650	20	1910	775,000	64 x 35 x 61
HDS 9.5/30 Ef ST LP	1.109-795.0	9.5	3000	575V / 3ph	26	KX1036R / 1650	20	1910	775,000	64 x 35 x 61
HDS 9.5/30 Eh ST LP	1.109-796.0	9.5	3000	208V / 3ph	52	KX1036R / 1650	20	1910	775,000	64 x 35 x 61

\*Propane regulator and power cord sold separately

## LIBERTY HDS CABINET



### Cleaning technology for indoors.

This Kärcher all-electric hot water pressure washer introduces hot-water tank technology to deliver hot water on demand ideal for indoor cleaning. Water is heated by flowing through a coil inside an 80-gallon water tank. Heating elements generate 138,000 BTU to produce hot water of up to 180°F. Both models are ETL and CSA certified.



#### Features

- Quiet, enviro-clean and user friendly
- Rust-free stainless steel coil enhances high-efficiency heat transfer
- Auto start-stop for on-demand cleaning
- Kärcher Belt-drive pump with 7-year warranty

#### Technical Data

Model	Part No.	GPM	PSI	HP	Electrical	Amps	Pump	Weight (lbs.)	Dimensions (L x W x H) inches
HDS 4.0/20 E Ec	1.109-075.0	4.2	2000	6.2	460V / 3ph	55	Kärcher KM	640	32 x 24 x 52
HDS 4.0/30 E Ec	1.109-076.0	3.5	3000	7.5	460V / 3ph	59	Kärcher KM	640	32 x 24 x 52

#### Options (factory installed)

Product	Order No.	Description
Time delay shutdown	9.801-012.0	Time delay shutdown (replaces auto start-stop)
Cabinet	9.801-002.0	Pressure washer stainless steel cabinet

## LIBERTY HDS P/PE CAGE

### Outstanding on all terrains.



Built on a rugged 1-1/4" powder coated steel frame, these compact gas roll cage models are designed for construction sites, farms and factories. The different models deliver hot water cleaning of up to 3500 PSI. Each features a Kärcher pump with limited 7-year warranty, industrial-grade motor and flat-free tires. All are certified to UL and CSA safety standards.

#### Features

- Direct-drive tri-plunger pumps
- Stainless steel coil wrap standard
- Rugged frame with powder finish
- Flat-free tires
- Schedule 80 heating coil
- ETL certified to UL & CSA Safety Standards

#### Technical Data

Model	Part No.	GPM	PSI	CC	Engine	Start	Pump	Burner	Weight (lbs.)	Dimensions (L x W x H) inches
HDS 2.8/25 P Cage	1.575-555.0	2.7	2400	211	Subaru EX21	Recoil	Kärcher KG	12V DC	404	50 x 40 x 50
HDS 2.6/30 P Cage	1.575-550.0	2.6	3000	270	Honda GX270	Recoil	Kärcher KG	12V DC	500	39 x 28 x 42
HDS 3.5/30 P Cage	1.575-551.0	3.5	3000	337	Honda GX340	Recoil	Kärcher KS	12V DC	550	46 x 28 x 44
HDS 3.5/30 Pe Cage	1.575-552.0	3.5	3000	337	Honda GX340	Electric	Kärcher KS	12V DC	560	46 x 28 x 44
HDS 3.5/35 Pe Cage	1.575-553.0	3.5	3500	389	Honda GX390	Electric	Kärcher KS	12V DC	595	46 x 28 x 44

#### Options (field installed)

Product	Order No.	Description
100' EZEE hose reel kit	9.801-024.0	100' EZEE hose reel kit (hose not included)
100' Pivot Hose Reel Kit	9.804-570.0	100' pivot hose reel kit (hose not included)

## LIBERTY HDS PE CAGE



### Optimum performance at remote locations.

These durable, skid-mounted models are designed for optimum cleaning performance at remote locations and feature Kärcher's unique 12V downdraft burner system. The highly compact burner is more than 92% efficient, resulting in better heat transfer using much less fuel. They feature belt-drive crankcase-style pumps. Certified to UL and CSA safety standards.



#### Powerful and durable

- Industrial-duty, tri-plunger, oil-bath, belt-drive Kärcher KT pump with 7-year warranty, brass pump head, and Tru-Trak belt adjustments; operates at a low RPM for low-maintenance operation and long life.
- Heavy-gauge 11/4" steel frame with powder coat finish for all-weather protection; with vibration isolators and forklift guides.
- Reliable gas-powered engines with electric start.
- Proprietary scale inhibiting system prevents build-up of mineral deposits inside the coil.
- 11 gallon polyethylene diesel and gasoline tanks for hours of uninterrupted operation.
- Warning lights monitor fuel and scale inhibitor levels; low-fuel shut-off protects fuel pump.

#### Smart features

- Kärcher's 92% efficient top-fired burner delivers more heat from less fuel for the lowest operating costs in the industry.
- Detergent metering valve allows for infinitely variable application of soap while washing in high-pressure mode.
- 50' Kärcher high-pressure steam hose rated for 311°F connects to the gun with an integrated swivel connection.
- Infinitely variable operating pressure, water volume, temperature control, and detergent metering.
- Unsurpassed Kärcher safety features include pressure switches, rupture disk, low-water and low-fuel protection that shuts down burner when incoming water and fuel are insufficient or interrupted.
- Ergonomically designed soft-grip Easy Press trigger gun minimizes operator fatigue.

#### Features

- Rugged frame construction
- Reliable belt-drive crankcase pumps
- Compact and highly-efficient burner
- Low-fuel cut off
- Anti-scale system - RM 110h
- Electric start engine

#### Technical Data

Model	Part No.	GPM	PSI	CC	Engine	Fuel	Pump	Weight (lbs.)	Dimensions (L x W x H) inches
HDS 4.0/32 Pe Cage	1.575-615.0	4.0	3200	389	Honda GX390	Gas	Kärcher KT	692	51 x 33 x 43
HDS 5.0/32 Pe Cage	1.575-616.0	5.0	3200	479	Vanguard 16	Gas	Kärcher KT	760	51 x 33 x 43
HDS 5.5/35 Pe Cage	1.575-155.0	5.5	3500	688	Honda GX630	Gas	Kärcher KT	741	51 x 33 x 43

## LIBERTY HDS PE/DE CAGE



### The industrial workhorse.

Kärcher Series oil-fired skids are the workhorses of the pressure washer industry. Delivering up to 5.6 GPM of hot water at up to 3500 PSI, these rugged gas and diesel-powered machines are built on an open frame using heavy-gauge 1-1/4" powder coated steel and are ideal for mounting in a truck or on a trailer. The electric-start engine and powerful belt-drive Kärcher KT pump are isolated from the rest of the machine on a shock-mounted sub-frame to reduce vibration. Steam combination comes standard with all models.



#### Features

- Honda, Vanguard, Kubota engines
- 1-1/4" full steel skid frame
- Burner available in 12V DC or 12V AC
- Kärcher belt-drive tri-plunger pumps
- 1/2" Schedule 80 heating coil
- North American-style accessories
- Stainless steel coil wrap
- Power generator on select models
- Electric start engines

#### Technical Data

Model	Part No.	GPM	PSI	CC	Engine	Fuel	Pump	Burner	Weight (lbs.)	Dimensions (L x W x H)
HDS 3.9/30 Pe Cage	1.575-600.0	3.9	3000	389	Honda GX390	Gas	Kärcher KT	12V DC	790	41 x 41 x 41
HDS 4.8/30 Pe Cage	1.575-601.0	4.8	3000	479	Vanguard 16	Gas	Kärcher KT	12V DC	800	41 x 41 x 41
HDS 4.8/30 Pe Cage	1.575-602.0	4.8	3000	479	Vanguard 16	Gas	Kärcher KT	120V AC	945	41 x 41 x 41
HDS 4.7/35 Pe Cage	1.575-603.0	4.7	3500	688	Honda GX630	Gas	Kärcher KT	12V DC	855	41 x 41 x 41
HDS 4.7/35 Pe Cage	1.575-604.0	4.7	3500	688	Honda GX630	Gas	Kärcher KT	120V AC	890	41 x 41 x 41
HDS 5.6/35 Pe Cage	1.575-605.0	5.6	3500	688	Honda GX660	Gas	Kärcher KT	12V DC	852	41 x 41 x 41
HDS 5.6/35 Pe Cage	1.575-606.0	5.6	3500	688	Honda GX660	Gas	Kärcher KT	120V AC	970	41 x 41 x 41
HDS 5.6/35 De Cage	1.110-622.0	5.4	3500	1123	Kubota D1105-E3B	Diesel	Kärcher KT	12V DC	1214	44 x 51 x 41
HDS 5.6/35 De Cage	1.110-623.0	5.4	3500	1123	Kubota D1105-E3B	Diesel	Kärcher KT	120V AC	1300	44 x 51 x 41

#### Options (factory installed)

Product name	Order No.	Description
Wheel Kit Assembly	9.801-003.0	Wheel kit assembly (gas engine skid only)
Stackless Flue Adapter	8.903-430.0	Stackless flue adapter

#### Options (field installed)

Product	Order No.	Description
Battery	8.904-051.0	Battery installed on Honda GX630 and GX660 models only

## LIBERTY HDS HEATER



### Hot Water Heater.

#### For attaching to a cold water pressure washer

Our Kärcher Series water heater provides supplemental heat to cold water machines, giving users the benefits of hot water cleaning when it's needed. An electric-powered diesel heated unit, the Heater 5.0/30 Ed effectively heats water at a rate of up to 5 gallons per minute.



#### Features

- Leak-free steel-pipe heating coil
- Effective heating of up to 5 GPM
- ETL certified to UL & CSA standards

#### Technical Data

Model	Part No.	GPM	PSI	Electrical	Amps	Heated by	Weight (lbs.)	Dimensions (L x W x H) inches
Heater 5.0/30 Ed	1.575-650.0	to 5	up to 3000	120V / 1ph	5	Diesel	330	29 x 41 x 47



## LIBERTY HD WALL MOUNTED



### Features

- Accepts hot water up to 180 degrees
- Remote on/off switch
- Kärcher Triplex crankcase pump

## Convenient and quiet.

Kärcher's wall-mount unit has a durable steel frame, uses a quiet 1725 RPM motor, and is perfect for in-shop uses. A remote on/off switch with a 10' electrical cord allows the machine to be mounted high on a wall away from back-spray. ETL certified to UL and CSA safety standards.



Shown with optional wall mount bracket part no. 8.920-952.0

### Technical Data

Model	Part No.	GPM	PSI	HP	Electrical	Amps	Pump	Weight (lbs.)	Dimensions (L x W x H) inches
HD 2.0/14 Ed +	1.107-088.0	1.8	1400	2	120V / 1ph	20	Kärcher KE	120	20 x 19 x 17

## LIBERTY HD HAND HELD



## Light weight and dependable.

These light-industrial hand held units are significantly more rugged than typical consumer substitutes and are built with durable steel frames. Hand-held models come with a dependable axial pump, high pressure hose, a stainless steel wand and detergent injector with brass soap nozzle.



### Features

- Durable steel frame
- Axial pump
- Portable, easy to transport

### Technical Data

Model	Part No.	GPM	PSI	HP	Electrical	Amps	Engine	Pump	Weight (lbs.)	Dimensions (L x W x H) inches
HD 2.0/10 Ed	1.575-400.0	2.0	1000	1.5	120V / 1ph	15		Comet Axial	80	24 x 19 x 22
HD 1.8/14 Ed	1.575-401.0	1.8	1400	2	120V / 1ph	20		Comet Axial	95	24 x 19 x 22
HD 2.3/23 P	1.575-351.0	2.3	2300	5			Honda GC160	Kärcher Axial	160	16 x 24 x 22
HD 2.3/24 P	1.575-350.0	2.3	2400	5.5			Honda GX160	Kärcher Axial	163	16 x 24 x 22

## LIBERTY HD CART

### Independent and versatile.

Our electric-powered machines are durable direct-drive units that can deliver cleaning volume of up to 3.5 GPM. Powered by heavy duty industrial-grade motors, these compact electric units feature tri-plunger oil bath Kärcher pumps, powder coated steel chassis, hose racks, detergent injection, insulated guns and wands, and tubed pneumatic tires. All models are ETL certified to UL and CSA safety standards.



#### Powerful and durable

- Industrial-duty Baldor motor with 36 ft. electrical cord and ground fault circuit interrupter (GFCI) for operator safety.
- Industrial-grade, tri-plunger, direct-drive Kärcher high pressure pump with forged brass head and ceramic pistons backed by a 7-year warranty.
- ETL certified to the rigid UL and CSA safety standards.

#### Outstanding mobility

- 10" tubed pneumatic tires for easy maneuvering on all terrains.
- Ergonomic high-pressure trigger gun for hours of fatigue-free cleaning.
- Integrated tilting aid at the rear.

#### Features

- Chrome handles
- Steel frame and chassis protected by powder coat finish
- Direct-drive Kärcher crankcase pump
- Available in 120V and 230V
- ETL certified to UL and CSA standards

#### Technical Data

Model	Part No.	GPM	PSI	HP	Electrical	Amps	Pump	Weight (lbs.)	Dimensions (L x W x H) inches
HD 2.0/10 Ed	1.575-250.0	2.0	1000	1.5	120V / 1ph	15	Kärcher KE	140	33 x 23 x 35
HD 1.9/15 Ed	1.575-251.0	1.9	1300	2	120V / 1ph	20	Kärcher KE	150	33 x 23 x 35
HD 2.8/10 Ed	1.575-252.0	2.8	1000	2	120V / 1ph	20	Kärcher KE	150	33 x 23 x 35
HD 3.5/20 Ea	1.575-253.0	3.5	2000	5	230V / 1ph	22	Kärcher KE	167	33 x 23 x 35

#### Options (field installed)

Product	Order No.	Description
100' EZEE hose reel kit	9.801-027.0	100' EZEE hose reel kit (hose not included)

## LIBERTY HD ROLL CAGE



### Specialty applications.

These belt-drive, electric roll cage models feature cleaning power of 5000 PSI and are available with either 230/3 phase or 460/3 phase motors. These units are specialty machines perfect for use in the marine market cleaning the bottom of boats or in the concrete industry, mixers, forms and handling equipment. Both models are ETL safety certified.



### Features

- Rugged steel chassis & roll cage
- Kärcher Belt-drive crankcase pump
- Cleaning power of 5000 PSI
- Flat-free tires
- 20 HP Baldor motor
- 50' high-pressure hose

### Technical Data

Model	Part No.	GPM	PSI	HP	Electrical	Amps	Pump	Weight (lbs.)	Dimensions (L x W x H) inches
HD 5.0/50 Eb Cage	1.107-084.0	5.0	5000	20	230V / 3ph	48	Kärcher KX	480	42 x 26 x 30
HD 5.0/50 Ec Cage	1.107-087.0	5.0	5000	20	460V / 3ph	26	Kärcher KX	480	42 x 26 x 30

### Options (field installed)

Product	Order No.	Description
100' hose reel kit	9.801-029.0	100' hose reel kit, 5000 PSI (hose not included)

# LIBERTY HD CABINET - BELT DRIVE



## Industrial throughout.

Our cold-water cabinet units really take the heat, accepting pre-heated water up to 180°F. Protected in durable steel cabinets, they demonstrate industrial strength throughout, including belt-drive Kärcher crankcase pumps, industrial motors, and magnetic starters for operator safety. All models are ETL certified to UL and CSA safety standards.



### 1 Wheel kit

- Wheel kit with detergent rack and optional hose reel.

### 2 Floor stand

- Floor stand with caster wheels.

## Technical Data

Model	Part No.	GPM	PSI	HP	Electrical	Amps	Pump	Weight (lbs.)	Dimensions (L x W x H) inches
HD 3.5/30 ST Ea B	1.575-306.0	3.5	3000	7.5	230V / 1ph	36	Kärcher KM	330	26 x 20 x 16
HD 3.5/30 ST Eb B	1.575-307.0	3.5	3000	7.5	230V / 1ph	19	Kärcher KM	275	26 x 20 x 16
HD 3.5/30 ST Ec B	1.575-308.0	3.5	3000	7.5	460V / 1ph	11	Kärcher KM	270	26 x 20 x 16
HD 3.5/30 ST Eg B	1.575-309.0	3.5	3000	7.5	208V / 1ph	38	Kärcher KM	332	26 x 20 x 16
HD 3.5/30 ST Eh B	1.575-310.0	3.5	3000	7.5	208V / 3 p	23	Kärcher KM	271	26 x 20 x 16
HD 2.8/10 ST Ed B	1.575-300.0	2.8	1000	2	120V / 1ph	20	Kärcher KM	210	26 x 20 x 16
HD 4.2/20 ST Ea B	1.575-301.0	4.2	2000	6	230V / 1ph	29	Kärcher KM	285	26 x 20 x 16
HD 4.2/20 ST Eb B	1.575-302.0	4.2	2000	6	230V / 3ph	22	Kärcher KM	255	26 x 20 x 16
HD 4.2/20 ST Ec B	1.575-303.0	4.2	2000	6	460V / 3ph	11	Kärcher KM	260	26 x 20 x 16
HD 4.2/20 ST Eh B	1.575-305.0	4.2	2000	6	208V / 3ph	16	Kärcher KM	265	26 x 20 x 16

## Options (factory installed)

Product	Order No.	Description
Conversion to Stainless Steel Cabinet	9.801-002.0	Conversion to Stainless Steel Cabinet
Auto Start/Stop	9.801-011.0	Auto Start/Stop
Time-Delay Shutdown	9.801-012.0	Time-Delay Shutdown
Hour Meter	9.801-013.0	Hour Meter
Floor Stand	9.801-034.0	Floor Stand, 36" Tall
Floor Stand	8.903-617.0	Stainless Steel Floor Stand, 36" Tall
Floor Stand	8.941-546.0	Stainless Steel Floor Stand, without Hose Hanger
Caster Wheels	9.801-035.0	Caster Wheels for Floor Stand
Hose Reel Kit, Floor Stand Only	9.801-036.0**	Hose Reel Kit, Floor Stand Only, 100 ft, No Hose
Hose Reel Kit for Wheel Kit	8.750-476.0**	100' x 3/8" fixed base hose reel
Wall Mount	8.919-437.0**	Wall Mount
Kit	8.903-039.0**	Kit, Hose Reel w/Bracket for Stand & Wall Mount Kits

\*\*hose not included

## Options (field installed)

Wheel Kit	9.801-031.0	Wheel Kit with Detergent Rack
Wall Mount Kit	9.801-033.0	Wall Mount Kit
Wall Mount Kit	8.903-043.0	Stainless Steel Wall Mount Kit
Floor Stand	8.903-040.0	Floor Stand, 24" short

## HD RESIDENTIAL



### Easy to use and durable.

Kärcher offers a line of gas-powered, direct-drive cold water pressure washers designed for residential use. They are easy to use and transport.

#### Features

- Durable steel frame
- Portable, easy to transport
- 1-year pump warranty

#### Technical Data

Model	Part No.	GPM	PSI	CC	Engine	Fuel	Pump	Weight (lbs.)	Dimensions (L x W x H) inches
HD 2.3/26 CV*	1.107-077.0	2.3	2600	160	Honda GCV160	Gas	Kärcher Axial	78	21 x 23 x 31
HD 2.5/30 CH	1.107-078.0	2.5	3000	190	Honda GC190	Gas	Kärcher Axial	77	21 x 23 x 35
HD 3.6/40 CH	1.107-079.0	3.6	4000	389	Honda GX390	Gas	Kärcher Axial	144	37 x 24 x 31

\* Performance certified to PWMA standard +/- 20% of advertised specifications

## XPERT SERIES HD



### Practical and robust.

Kärcher's Xpert series is a professional-grade line of cold water pressure washers. Powered by reliable Honda engines, Kärcher offers your choice of 160CC units with axial pumps or 196CC and 389CC units with Kärcher crankcase pumps. These Xpert units feature commercial-duty guns and wands and come with downstream chemical injection, four hardened stainless steel quick-couple nozzles. The precision welded frames and pneumatic tires make these pressure washers easy to maneuver on any terrain.



#### Features

- Reliable Honda engines
- Axial or crankcase pumps
- Welded steel chassis protected by all weather, epoxy powder coat finish
- EZEE pull starting
- Pneumatic tires
- UL safety certification

#### Technical Data

Model	Part No.	GPM	PSI	CC	Engine	Fuel	Pump	Weight (lbs.)	Dimensions (L x W x H) inches
HD 2.3/23 PS KAR	1.107-104.0	2.3	2300	160	Honda GC160	Gas	Kärcher Axial	72	37 x 24 x 31
HD 2.3/23 P COM	1.107-1030	2.3	2300	160	Honda GC160	Gas	Comet Axial	73	37 x 24 x 31
HD 2.5/27 P	1.107-106.0	2.5	2700	196	Honda GX200	Gas	Kärcher KG	99	37 x 24 x 31
HD 3.8/35 P	1.107-108.0	3.8	3500	389	Honda GX390	Gas	Kärcher KS	157	37 x 24 x 31
HD 3.5/40 P	1.107-219.0	3.5	4000	389	Honda GX390	Gas	Kärcher KS	157	37 x 24 x 31

# LIBERTY HD HANDTRUCK



## Ideal performance and value.

This series of commercial-duty, gas-powered cold water pressure washers offers the ideal balance between professional performance and value. Powered by reliable Honda engines, all four models have Kärcher's German-engineered, direct-drive axial pump, rugged steel frame with handtruck design, tubed pneumatic tires and 50' of commercial-duty hose.



### Features

- Reliable Honda engines
- Kärcher Axial pump
- Reinforced upright steel frame
- Quick connect nozzles
- Onboard hose and wand storage

### Technical Data

Model	Part No.	GPM	PSI	CC	Engine	Fuel	Pump	Weight (lbs.)	Dimensions (L x W x H) inches
HD 2.5/24 P	1.575-105.0	2.5	2400	160	Honda GC160	Gas	Axial	148	35 x 21 x 24
HD 2.6/26 P	1.575-106.0	2.6	2600	187	Honda GC190	Gas	Axial	155	35 x 21 x 24
HD 3.1/31 P*	1.575-107.0	3.0	3000	270	Honda GX270	Gas	Axial	166	24 x 32 x 43
HD 4.0/36 P*	1.575-108.0	4.0	3600	389	Honda GX390	Gas	Axial	180	24 x 32 x 43

\*includes hose reel

### Options (field installed)

Product	Order No.	Description
100' non-pivot hose reel	9.801-253.0	100' non-pivot hose reel, hose sold separately

## LIBERTY HD CART



### Compact and dependable.

These Liberty Series models are tough gasoline-powered direct-drive cold water machines that deliver cleaning power of up to 4000 PSI. Built on compact sturdy steel frames, each unit features a dependable industrial-grade Honda engine, Kärcher crankcase pump, hose/gun rack, detergent injection, and tubed pneumatic tires. All models are ETL certified.



#### Features

- Chrome handles
- Steel frame with powder coat finish
- Commercial grade Honda GX engine
- Cleaning power up to 4000 PSI
- Industrial direct-drive Kärcher crankcase pump

#### Technical Data

Model	Part No.	GPM	PSI	CC	Engine	Fuel	Pump	Weight (lbs.)	Dimensions (L x W x H) inches
HD 2.3/24 P	1.575-100.0	2.3	2400	163	Honda GX160	Gas	Kärcher KG	148	35 x 21 x 24
HD 2.5/27 P	1.575-101.0	2.5	2700	196	Honda GX200	Gas	Kärcher KG	155	35 x 21 x 24
HD 3.0/30 P	1.575-102.0	3.0	3000	270	Honda GX270	Gas	Kärcher KG	175	35 x 21 x 24
HD 3.8/35 P	1.575-104.0	3.8	3500	389	Honda GX390	Gas	Kärcher KS	180	35 x 21 x 24
HD 3.5/40 P	1.107-223.0	3.5	4000	389	Honda GX390	Gas	Kärcher KS	180	35 x 21 x 24

#### Options (field installed)

Product	Order No.	Description
100' EZEE Hose Reel Kit	9.801-026.0	100' EZEE Hose Reel kit (hose not included)

## LIBERTY HD PB CART



### Reliable and professional.

Our cold-water series provides a broad selection of rugged belt-drive units, all with reliable Honda GX engines, which deliver cleaning volume of up to 3.7 GPM. Each model is ETL certified to UL safety standards and comes with a rugged steel chassis, cast iron belt pulley system, flat-free tires, and industrial-grade Kärcher crankcase pump.



#### Features

- Chrome handles
- Powder coated steel chassis
- Reliable Honda GX engine
- Onboard hose and wand storage
- Water volume up to 3.7 GPM
- Industrial belt-drive Kärcher pump
- Flat-free tires
- Quick connect nozzles

#### Technical Data

Model	Part No.	GPM	PSI	CC	Engine	Fuel	Pump	Weight (lbs.)	Dimensions (L x W x H) inches
HD 3.0/30 PB	1.575-152.0	3.0	3000	270	Honda GX270	Gas	Kärcher KM	225	45 x 26 x 24
HD 3.7/35 PB	1.575-154.0	3.7	3500	389	Honda GX390	Gas	Kärcher KM	250	45 x 26 x 24
HD 3.0/40 PB	1.575-155.0	3.0	4000	389	Honda GX390	Gas	Kärcher KM	250	45 x 26 x 24



## LIBERTY HD ALUMINUM SERIES



### Corrosion-resistant and easy operation.

Kärcher's Aluminum Liberty Series HD pressure washer offers commercial grade cleaning in a light-weight, corrosion-resistant and easily mobile design. Built with a weldless aluminum frame, these units provide best-in-class maneuverability and are easy to push and pull, thanks to their innovative shape and weight distribution. Cast aluminum rotary joints allow for easy transport, easy storage and ergonomic operation. All models are ETL certified to UL safety standards.



#### Features

- Weldless aluminum frame
- Cast aluminum rotary joints
- Quick-couple high pressure nozzles
- On-board hose/wand hanger
- 7-year pump warranty

#### Technical Data

Model	Part No.	GPM	PSI	CC	Engine	Drive	Fuel	Pump	Weight (lbs.)	Dimensions (L x W x H) inches
HD 2.5/27 P AL	1.107-129.0	2.5	2700	196	Honda GX200	Direct	Gas	Kärcher KG	125	50 x 57 x 41
HD 3.0/30 P AL	1.107-130.0	3.0	3000	270	Honda GX270	Direct	Gas	Kärcher KD	148	50 x 57 x 41
HD 3.8/35 P AL	1.107-131.0	3.8	3500	389	Honda GX390	Direct	Gas	Kärcher KS	172	50 x 57 x 41
HD 3.5/40 P AL	1.107-129.0	3.5	4000	389	Honda GX390	Direct	Gas	Kärcher KS	172	50 x 57 x 41
HD 2.5/27 PB AL	1.107-132.0	2.5	2700	196	Honda GX200	Belt	Gas	Kärcher KD	196	50 x 57 x 41
HD 3.7/35 PB AL	1.107-133.0*	3.7	3500	389	Honda GX390	Belt	Gas	Kärcher KM	249	50 x 57 x 41

\* includes flat-free tires

#### Options (field installed)

Product	Order No.	Description
Detergent injector	8.929-062.0	Detergent injector up to 3 GPM
Detergent injector	9.802-225.0	Detergent injector over 3 GPM
Detergent nozzle	8.723-636.0	Detergent nozzle
Dirt Blaster nozzle	4.767-041.0	Dirt Blaster nozzle - HD 2.5/27 P AL
Dirt Blaster nozzle	9.302-447.0	Dirt Blaster nozzle - HD 3.0/30 P AL
Dirt Blaster nozzle	9.302-443.0	Dirt Blaster nozzle - HD 3.8/35 P AL

## LIBERTY HD PB/DB CAGE



### Extra rugged and powerful.

Our roll cage models are the most powerful units in our cold water line, with cleaning power of up to 5000 PSI. Protected by a rugged powder coated roll cage built of 1-1/4" steel, the PB Cage units feature powerful Vanguard, Honda or Kohler engines, tri-plunger oil bath Kärcher pumps, flat-free tires, and an extra rugged belt-drive assembly with notched V belts and cast iron pulleys. All single and double-axle models are ETL safety certified.



#### Features

- Belt-drive
- Rugged steel chassis & roll cage
- Powerful Honda, Vanguard or Kohler engine
- Cleaning power up to 5000 PSI
- Electric start on dual-axle models\*
- Industrial belt-drive Kärcher pump with 7-year warranty
- Flat-free tires

#### Technical Data

Model	Part No.	GPM	PSI	CC	Engine	Fuel	Pump	Weight (lbs.)	Dimensions (L x W x H) inches
HD 3.7/35 PB Cage	1.575-205.0	3.7	3500	389	Honda GX390	Gas	Kärcher KM	350	42 x 26 x 30
HD 4.0/40 PB Cage	1.575-207.0	4.0	4000	479	Vanguard 16	Gas	Kärcher KM	470	42 x 26 x 30
HD 4.0/50 PeB Cage*	1.575-200.0	4.0	5000	688	Honda GX630	Gas	Kärcher KM	495	42 x 26 x 30
HD 4.5/50 PeB Cage*	1.575-201.0	4.5	5000	688	Honda GX660	Gas	Kärcher KM	500	42 x 26 x 30
HD 3.4/30 DeB Cage*	1.575-202.0	3.4	3000	404	Kohler KD420	Diesel	Kärcher KM	410	42 x 26 x 30

#### Options (field installed)

Product	Order No.	Description
100' EZEE Hose Reel Kit	9.801-028.0	100' EZEE Hose Reel kit, single axle (hose not included)
100' Hose Reel Kit	9.801-029.0	100' Hose Reel kit, 5000 psi, double axle (hose not included)

# LIBERTY HD UTV SKID



## Portability - UTV skid.

This rugged and light weight cold water skid is designed to easily mount in the back of most all terrain utility vehicles and pick-up trucks, allowing you ultimate portability and power in a cold water unit. The UTV is powered by a reliable Subaru EX gas engine and Kärcher crankcase pump, has a rugged steel base with forklift openings on the front and a 50' high pressure hose that connects to a Professional-Duty gun and wand.



### 1 Easy to transport

- With a width of less than 50", it easily mounts in the back of UTVs.
- Forklift openings on the front of the skid for convenient loading and unloading.

### 2 Rugged design

- Heavy gauge steel fabrication 100' hose reel. Easy to use break mechanism reduces unwinding backlash, oversized heavy-duty locking mechanism prevents slippage during reel operation. Durable handle.

## Features

- Kärcher crankcase pump with U-Seal technology and 7-Year Warranty
- Thermal Pump Protection protects the pump from overheating if left in bypass
- 65 gallon water tank
- Forklift openings on front of skid
- Complete set of quick connect nozzles
- 3/8", 50' Hose with quick connects

## Technical Data

Model	Part No.	GPM	PSI	CC	Engine	Fuel	Pump	Weight (lbs.)	Dimensions (L x W x H) inches
HD 2.5/27 P UTV	1.107-233.0	2.3	2700	169	Subaru EX17	Gas	Kärcher KG	490	40 x 48 x 35

## Options (field installed)

Product	Order No.	Description
Feet Kit	8.923-105.0	Rubber Feet Kit
Filter Kit	8.923-107.0	Inlet Filter Kit
Eye Bolts Kit	8.923-106.0	Lifting Eye Bolts Kit
Valve Kit	8.923-108.0	Three-Way Valve Kit

# TRK-2500



Shown with optional hot water pressure washer skid

## High cleaning performance.

Kärcher's TRK-2500 pressure washer trailer is designed to accommodate a variety of pressure washer skids. This trailer package is rugged, affordable, versatile, and easy to ship and store.

The TRK-2500 is made of rugged 10-gauge steel. The wheel and axle assembly features leaf-spring suspension of up to 3,500 lbs. The 39-inch tongue features a swing-away hinge that saves on storage space.

### Features

- Electrical wiring recessed within tubular frame
- Lighted license plate holder and recessed tail lights
- 1,000 lb. swivel jack with a 2-inch ball coupler for quick and easy hook up of the trailer
- 3-way ball valve for easy switching of the water flow from the holding tank to a faucet
- High-density, polyethylene 200-gallon water tank with a 12-inch access port, 1 1/2-inch drain valve, 3/4-inch float valve and a 50-mesh inlet filter; and two 5/16-inch chains for additional safety

### Technical Data

Model	Part No.	Axle	(GVWR) lbs.	Water tank (gallons)	Ship weight (lbs.)*
TRK-2500	1.103-819.0	Single	2500	200	1072

\*trailer and water tank only

### Options

Skid Mounting Kit	8.917-294.0	Liberty Series Skid mounting kit (required for mounting pressure washer to trailer)
-------------------	-------------	---

### Options (field installed)

Saddle Box	8.917-558.0	Saddle Box (each)
Rock Guard	8.917-559.0	Rock Guard
Utility Rack	8.917-560.0	Utility Rack

### Options (factory installed)

Brakes	8.917-397.0	Electric Brakes
Brake Breakaway Kit	8.917-553.0	Electric Brake Breakaway Kit
Brakes	8.917-398.0	Hydraulic Brakes
Hose Reel Kit	8.917-554.0	High Pressure Hose Reel Kit
Hose Reel Kit	8.917-555.0	Low Pressure Hose Reel Kit
Saddle Boxes	8.917-556.0	Saddle Boxes (2)
Rock Guard	8.917-557.0	Rock Guard
Battery	8.904-051.0	Battery Installed on Pressure Washer

## TRK-6000, TRK-3500



**TRK-6000** - shown with options and gas-powered hot water pressure washer; accommodates both gas and diesel-powered pressure washers.

### Features

- Electrical wiring recessed within tubular frame
- Lighted license plate holder and recessed tail lights
- 1,000 lb. swivel jack with a 25/16-inch ball coupler for quick and easy hook up of the trailer.
- Two 3-way ball valves for easy switching of the water flow from the holding tank to a faucet

- Rugged steel cage for security while transporting.
- High-density, polyethylene water tank with a 12-inch access port, 1 1/2-inch drain valve, 3/4-inch float valve and a 50-mesh inlet filter; and two 5/16-inch chains for additional safety.

### Technical Data

Model	Part No.	Axle	(GVWR) lbs.	Water tank (gallons)	Ship weight (lbs.)*
TRK-6000	1.103-807.0	Tandem	6000	330	1980
TRK-3500	1.103-806.0	Single	3500	200	840

\*trailer and water tank only



**TRK-3500** - shown with options; accommodates gasoline-powered pressure washers only.

### Options

Order No.	Description
8.904-051.0	Battery installed on pressure washer
8.902-437.0	Electric brake, one axle, trk-6000
8.902-445.0	Electric brake, two axles, trk-6000
8.902-440.0	Electric brake, trk-3500
8.902-436.0	Height adjustable hitch w/ 3-in. Lunette eye (replaces ball coupler)
8.707-532.0	2-inch ball coupler (fits height adjustable hitch 8.902-436.0 Above)
8.707-531.0	2-5/16-Inch ball coupler (fits height adjustable hitch 8.902-436.0 Above)
8.917-553.0	Kit, breakaway actuator with battery
8.902-438.0	Hydr. brake, one axle, trk-6000 with 2-in. Ball coupler
8.902-446.0	Hydr. brake, two axles, trk-6000 with 2-in. Ball coupler
8.902-441.0	Hydr. brake, trk-3500 with 2-inch ball coupler
8.902-451.0	Hydr. brake, one axle, trk-6000 w/ height adj. Hitch (specify coupler below)
8.902-452.0	Hydr. brake, two axles, trk-6000 w/ height adj. Hitch (specify coupler below)
8.902-453.0	Hydr. brake, trk-3500, w/ height adjustable hitch (specify coupler below)
8.707-532.0	Coupler, 2-inch ball (fits height adjustable hitch 8.902-451.0 & 8.902-453 above)
8.707-531.0	Coupler, 2-5/16-inch ball (fits height adjustable hitch 8.902-451.0 & 8.902-453 above)
8.707-534.0	Coupler, 3-inch lunette eye (fits height adjustable hitch 8.902-451.0 & 8.902-453 above)

### Options

Order No.	Description
8.915-156.0	High-pressure hose, 3/8-inch x 100 ft., 2-Wire, installed
8.902-447.0	Hose reel kit for 100 ft. Of 3/8-inch high-pressure hose
8.902-448.0	Hose reel kit for 200 ft. Of 3/8-inch high-pressure hose
8.902-449.0	Hose reel kit for 75 ft. Of 3/4-inch industrial garden hose
8.902-455.0	Skid mounting & plumbing kit (required for mounting pressure washer to trailer)
8.902-469.0	Sign plate
8.902-466.0	Chrome wheels, pair, (2 pair required for trk-6000)
8.902-468.0	Chrome fenders, pair, trk-6000 tandem axle
8.902-467.0	Chrome fenders, pair, trk-3500 single axle

## KÄRCHER ORIGINAL ACCESSORIES.

Kärcher original accessories extend the range of applications of the high-pressure cleaner. In order to meet our customers' requirements, we continuously further develop our accessories. This results in innovative products designed to facilitate daily cleaning tasks.



Solar cleaning	Page	39	Surface cleaners	Page	61
High-pressure hoses	Page	41	Wet blasting	Page	63
Hose reels	Page	46	Foam systems / Cleaning agent injectors	Page	64
Couplings	Page	48	Other accessories	Page	65
Wash brushes	Page	48	Pumps, repair kits	Page	67
Trigger guns	Page	49	Tools	Page	76
Spray wands	Page	51	Coils	Page	77
Nozzles	Page	53	Burners	Page	79
Pipe cleaning	Page	60			



### 1 Trigger guns

Kärcher Easy Press hand spray gun: top in performance and operation.

- **Easy Press:** reduced operating fatigue due to ergonomic design.
- **Soft-grip insert:** for comfort when holding the trigger gun.
- **Servo Control:** Precise control of pressure and water volumes - while in operation.
- **AVS:** Non-twist hoses due to rotating connection.

### 2 Hoses

The unique Kärcher 2000 coupling system allows hoses and machines to be connected or disconnected quickly and safely. All Kärcher high-pressure hoses are built to the highest standards.

### 3 Hose risers and stackable reels

Easily manage high-pressure hoses with a new series of accessories from Kärcher. Move up to 400' of hose in place with stackable hose reels and cart. Maneuver over obstacles and make cleaning easier with the adjustable hose riser.

### 4 iSolar - Photo-voltaic cleaning

iSolar modularity allows for safe and efficient cleaning of photo-voltaic systems of any size. Rotating disc brushes on telescopic wands, of various lengths, are driven by the water from the high-pressure cleaner.

### 5 Innovative surface cleaning

The FRV 30 surface cleaner cleans surfaces quickly without splashing and automatically vacuums the dirty water, eliminating the need to rinse the surface after cleaning. Now also available in the hot water-resistant stainless steel version FRV 30 Me.

## iSolar 400/800 SOLAR PANEL CLEANER



The iSolar accessories system is a complete modular solution that offers all the necessary products for your cleaning needs, from water connections to brushes. This system is also compatible with many Kärcher pressure washers, meaning, existing pressure washers can usually be used to operate iSolar. Because the system is modular, we can build a custom solution to fulfill any requirement.

The iSolar 400 and iSolar 800 offer superior and safe cleaning, thanks to brushes powered by a pressure washer's water jet. The mechanical action of the bristles, made of nylon for scratch-free surface cleaning, operate at low pressure, eliminating any danger of the panels being damaged. The rotating brushes are also fitted with robust ball bearings to guarantee exceptionally long service life.



### 1 iSolar 800

Counter-rotating disc brushes ensure:

- Excellent cleaning performance and area coverage
- Optimal handling with balancing of transverse forces
- Pre-rinsing of adjacent panels

### 2 Comfortable in every position

Stable articulated joint offers:

- Convenient and flexible working positions
- Robust brass design for maximum durability

### 3 iSolar 400

Entry-level model for smaller areas:

- Particularly suitable for elevated systems
- Pre-rinsing of adjacent panels

### 4 Safety first

For safe rooftop work:

- Safety harness with quick-release fasteners
- Guided fall arrestor with integrated shock absorber and lengthy guide rope



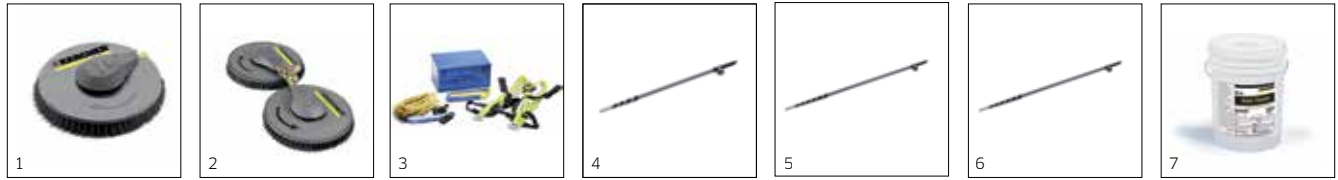

		Order no.	Length	Flow rate	Max. feed temperature	Description
<b>iSolar panel cleaner</b>						
iSolar 400	1	6.368-457.0		4.85-5.72 GPM	104 °F	The water-driven iSolar 400 disc brush features a working width of 400 mm and is especially suitable for cleaning small to medium-sized photo-voltaic systems. Thanks to the low weight and easy handling, even elevated systems can be conveniently cleaned.
iSolar 800	2	6.368-455.0		> 4.84 GPM	104 °F	The water-driven iSolar 800 brush head with 800 mm working width works with two contra-rotating disc brushes and is used for cleaning photo-voltaic systems. The contra-rotating brushes balance out all transversal forces, guaranteeing optimal handling. The flexible angle joint on the brush head's connector also makes cleaning easier. It ensures that the bristles always lie flat, allowing uniform cleaning results. The brush head features especially high area performance - ideal for cleaning large systems, for example on barn roofs.
Safety kit	3	6.988-152.0				Certified, standard-compliant safety system for safe working on roofs. The fall protection includes a traveling fall arrestor with shock absorber and 15 m kernmantle rope, safety harness, an anchoring loop for fixing the safety machine, as well as a practical metal box for storage and transport.
iSolar TL 7 H	4	4.107-054.0	5-23 ft.		140 °F	Telescopic wand made from carbon/fiberglass mixture for maximum rigidity with minimum weight. With a 7.2 m maximum reach and practical quick-release couplings for easy extension and retraction.
iSolar TL 10 C	5	4.107-055.0	7-33 ft.		140 °F	The water-driven iSolar 800 brush head with 800 mm working width works with two contra-rotating disc brushes and is used for cleaning photo-voltaic systems. The contra-rotating brushes balance out all transversal forces, guaranteeing optimal handling. The flexible angle joint on the brush head's connector also makes cleaning easier. It ensures that the bristles always lie flat, allowing uniform cleaning results. The brush head features especially high area performance - ideal for cleaning large systems, for example on barn roofs.
iSolar TL 14 C	6	4.107-052.0	7-45 ft.		140 °F	The telescopic lance is made from a carbon-fiberglass mixture (hybrid) and offers maximum rigidity with minimum weight. It has a reach of up to 7.2 m and is fitted with practical quick-release couplings - for convenient extension and retraction. The speed is regulated via ball tap, guaranteeing easy handling. The carbon-fiberglass mixture is also on the lowest rod element and ensures electrical insulation and thus work safety.
RM 99 solar cleaner	7	8.698-094.0				The telescopic lance is made from a carbon-fiberglass mixture (hybrid) and offers maximum rigidity with minimum weight. It has a reach of up to 10 m and is fitted with practical quick-release couplings - for convenient extension and retraction. The speed is regulated via ball tap, guaranteeing easy handling. The carbon-fiberglass mixture is also on the lowest rod element and ensures electrical insulation and thus work safety.

# HIGH-PRESSURE HOSES



Kärcher's original equipment hoses are the preferred choice of experienced pressure washer operators. Constructed of the highest-quality materials available, our anti-kink hoses deliver outstanding durability and improved operator convenience. Kärcher hoses are more flexible and easier to wind than competitors' hoses and are more convenient to use thanks to easy-grip hose-ends which can be tightened without tools.

		Order no.	Max Temp	Max working pressure (PSI)	Length (ft.)	Description
<b>Integral AVS connection - passive swivel</b>						
High-pressure hose, 10 m, ID 6, AVS trigger gun connector	1	6.391-238.0	311 °F	3625	33	With patented AVS trigger gun connector (rotatable) and coupling, M 22 x 1.5 with anti-kink sleeve.
High-pressure hose, 10 m, ID 6, AVS trigger gun connector	2	6.390-174.0	311 °F	3625	50	With patented AVS trigger gun connector (rotatable) and manual coupling, M 22 x 1.5 with anti-kink sleeve.
<b>Integral AVS connection</b>						
High-pressure hose, 10 m, ID 6	3	6.389-853.0	311 °F	3625	33	Integral AVS connection
High-pressure hose, 10 m, ID 8	4	6.390-025.0	311 °F	4565	33	
High-pressure hose, 15 m, ID 8	5	6.390-185.0	311 °F	4565	50	
High-pressure hose, 20 m, ID 8	6	6.390-171.0	311 °F	4565	66	
<b>Female twist-type connection (22 mm)</b>						
High-pressure hose, 10 m, ID 8, extension piece		6.391-342.0	311 °F	4565	33	Female twist-type connection (22 mm)
High-pressure hose, 15 m, ID 8	7	6.390-010.0	311 °F	4565	50	
High-pressure hose, 30 m, ID 8	8	6.390-293.0	311 °F	4565	100	
High-pressure hose, 15 m, ID 10	9	6.390-023.0	311 °F	3190	50	
<b>Extension hose 2 x 22 mm (no swivel)</b>						
High-pressure hose, 15 m, ID 8  (requires 4.403-002.0 brass extension coupling to connect to other hose)	10	9.162-323.0	185 °F	4000	50	Extension hose 2 x 22 mm (no swivel)
High-pressure hose, 30 m, ID 8  (requires 4.403-002.0 brass extension coupling to connect to other hose)	11	9.162-305.0	311 °F	3600	100	

## LONG-LIFE HIGH-PRESSURE HOSES.



		Order no.	Max Temp	Max working pressure (PSI)	Length (ft.)	Description
<b>Premium long-life 400 hose (Integral AVS connection)</b>						
Integral AVS connection, 10 m, ID 8	12	6.391-351.0	311 °F	5800	33	Kärcher's premium Long-life 400 hoses, identified with a yellow stripe, are the best of the best and are available to fit AVS or 22 mm twist-type connections. This hose has an integral pivot end to fit AVS trigger guns and a 22 mm female threaded end with anti-kink protection.
Integral AVS connection, 20 m, ID 8	13	6.390-208.0	311 °F	5800	66	
<b>Premium long-life 400 hose (22 mm twist-type connection)</b>						
22 mm twist-type connection, 10 m, ID 8	14	6.388-083.0	311 °F	5800	33	The Long-life twist-type hose has two 22 mm female anti-kink threaded ends for non-AVS trigger guns. The yellow end indicates full 360° swivel capability at that point—even under full pressure.
22 mm twist-type connection, 15 m, ID 8	15	6.389-709.0	311 °F	5800	50	
22 mm twist-type connection, 20 m, ID 8	16	6.390-027.0	311 °F	5800	66	
22 mm twist-type connection, 30 m, ID 8	17	6.390-294.0	311 °F	5800	100	
<b>Food-grade hoses</b>						
High-pressure hose, 15 m, ID 6, AVS trigger gun connector 11 mm, suitable for food industry, gray	18	6.391-654.0	311 °F	3625	50	With patented AVS trigger gun connector (rotatable) and coupling, M 22 x 1.5 with anti-kink sleeve. With gray non-marking outer cover.
High-pressure hose, 10 m, ID 8, AVS gun connection, food, gray	19	6.390-704.0	311 °F	3625	33	
High-pressure hose, 15 m, ID 6, AVS gun connection, 15 mm, suitable for food	20	6.390-445.0	311 °F	3625	50	
High-pressure hose, 20 m, ID 8, AVS trigger gun connector, suitable for food industry, gray	21	6.390-705.0	311 °F	3625	66	
<b>Food industry version with unions on both sides</b>						
High-pressure hose, 10 m, ID 8, suitable for the food industry, extension piece	22	6.389-479.0	311 °F	3625	33	Connectors at both ends, M 22 x 1.5, with kink protection. With gray non-marking outer cover.
High-pressure hose, 20 m, ID 8, suitable for food industry, extension piece	23	6.389-581.0	311 °F	3625	66	
<b>Special hoses</b>						
High-pressure hose 20 m, ID 20, including connectors, outlet bend	24	6.391-886.0	311 °F	5800	66	High pressure hose for connection to hose reel.

## KÄRCHER TUFF-SKIN HOSE

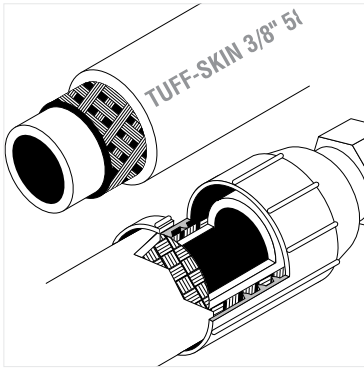

There is no other high-pressure hose as tough as Kärcher's Tuff-Skin™ hose. When tested to ISO 6945 / DIN 20024, the Tuff-Skin has proven to be seven times more abrasion resistant than standard pressure washer hoses, yet is 20% more flexible. The Tuff-Skin, with its unique design, has been engineered for a greater continuous temperature range – from -40° to 275°F / 310°F intermittent – and for handling pressures of up to 6000 PSI.

Beside its maximum-strength Class A ORS (Oil Resistance Standard) – most other brands are Class B – the Tuff-Skin has a “bite-the-wire” coupling that grips the hose better than any other design.

Both single-and double-wire braid hoses come with Kärcher's branded durable plastic sleeves on both ends – a 24-inch sleeve on the gun end – for added operator protection against high-pressure bursts.

		<b>Order no.</b>	<b>Max Temp</b>	<b>Max working pressure (PSI)</b>	<b>Length (ft.)</b>	<b>Description</b>
<b>Kärcher Tuff-Skin, 2-wire</b>						
3/8" ID	1	8.739-065.0	275 °F	6000	25	Wrapped impression, maximum oil resistant tube and cover 2-wire protection Seven times greater abrasion resistance Built to SAE 100R2AT OD dimensions 3/8" MPT Swivel x 3/8" MPT Solid
	2	8.739-066.0	275 °F	6000	50	
	3	8.739-067.0	275 °F	6000	75	
	4	8.739-068.0	275 °F	6000	100	
3/8" (bulk hose)	5	8.724-042.0	275 °F	6000	400	
3/8" ID, (case of 40)	6	8.916-389.0	275 °F	6000	100	
<b>Kärcher Tuff-Skin, 1-wire</b>						
3/8" ID	7	8.739-020.0	275 °F	4000	25	Wrapped impression, maximum oil resistant tube and cover 1-wire protection Seven times greater abrasion resistance Built to SAE 100R2AT OD dimensions 3/8" MPT Swivel x 3/8" MPT Solid
	8	8.739-021.0	275 °F	4000	50	
	9	8.739-022.0	275 °F	4000	75	
	10	8.739-023.0	275 °F	4000	100	
	11	8.739-024.0	275 °F	4000	150	
3/8" (bulk hose)	12	8.724-037.0	275 °F	4000	500	

# KÄRCHER TUFF-FLEX HOSE

Tuff-Flex hose has the same durable cover as Tuff-Skin with a smaller outside diameter for greater flexibility!



1-6, 13-21



7-12



22-25



26-29

		<b>Order no.</b>	<b>Max Temp</b>	<b>Max working pressure (PSI)</b>	<b>Length (ft.)</b>	<b>Description</b>
<b>Kärcher Tuff-Flex, 2-wire</b>						
3/8" ID	13	8.739-202.0	275 °F	5000	25	Tuff-Flex hose has the same durable cover as the Tuff-Skin hose. A smaller OD allows for even greater flexibility.
	14	8.739-203.0	275 °F	5000	50	
	15	8.739-204.0	275 °F	5000	75	Wrapped impression, maximum oil resistant tube and cover 50% greater flexibility Seven times greater abrasion resistance
	16	8.739-205.0	275 °F	5000	100	
	17	8.739-206.0	275 °F	5000	150	
3/8" ID (case of 75)	18	8.916-391.0	275 °F	5000	50	Economically priced
3/8" ID (case of 40)	19	8.916-390.0	275 °F	5000	100	3/8" MPT Swivel x 3/8" MPT Solid or 1/2" MPT Swivel x 1/2" MPT Solid
1/2" ID	20	8.739-409.0	275 °F	4500	50	
1/2" ID	21	8.739-411.0	275 °F	4500	100	
<b>Kärcher Tuff-Flex, 2-wire</b>						
3/8" ID	22	8.739-207.0	275 °F	4000	25	Non-marking durable blue cover Red Kärcher branded hose guard 2-wire protection Smooth impression, maximum oil resistant tube and cover 50% greater flexibility 3/8" MPT Swivel x 3/8" MPT Solid
	23	8.739-208.0	275 °F	4000	50	
	24	8.739-209.0	275 °F	4000	75	
	25	8.739-210.0	275 °F	4000	100	
<b>Kärcher Tuff-Flex, 1-wire</b>						
3/8" ID	26	8.739-129.0	275 °F	3000	25	
	27	8.739-130.0	275 °F	3000	50	
	28	8.739-131.0	275 °F	3000	75	
	29	8.739-132.0	275 °F	3000	100	

## MISC HOSES

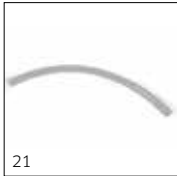

		Order no.	Max Temp	Max working pressure (PSI)	Length (ft.)	Description
<b>Water supply hose</b>						
	1	4.440-038.0	86°F		25	ID 13 R1" / R 3/4", up to 30 °C.
	2	4.440-207.0	86°F		25	ID 19 R1" / R 3/4", up to 85 °C, for suction with copper wire for grounding the unit.
<b>Industrial garden hose</b>						
3/4" ID	3	8.711-797.0	212 °F	200	25	Built to last, extra-large 3/4" ID Inlet water hose. EPDM cover and tube is perfect for water and provides ozone and heat protection. 2-wire protection Seven times greater abrasion resistance Built to SAE 100R2AT OD dimensions 3/8" MPT Swivel x 3/8" MPT Solid
	4	8.711-798.0	212 °F	200	50	
	5	8.711-799.0	212 °F	200	75	
	6	8.711-800.0	212 °F	200	100	
<b>Sandblast hose</b>						
3/4"	7	8.711-809.0	130 °F		/ ft.	Sand, Spiralite /ft
3/4" x 25'	8	8.711-839.0	130 °F		25	Assy, Sand, Spiralite
3/4" x 40'	9	8.711-840.0	130 °F		40	Assy, Sand, Spiralite
1"	10	8.711-811.0	130 °F		/ ft.	Sand, Spiralite /ft
<b>Float tank inlet hose</b>						
8"	11	8.711-773.0	190 °F	300		
11"	12	8.711-774.0	190 °F	300		
13"	13	8.711-775.0	190 °F	300		
30"	14	9.802-257.0	190 °F	300		
45"	15	9.802-258.0	190 °F	300		
Connector, Fluidmaster ball cock	16	8.707-316.0	190 °F	300		
<b>Push-on hose</b>						
1/4" ID	17	9.802-254.0	190 °F	300		This is a fabric braid hose with a Nitrile cover and tube. Easily pushes on to hose barb fitting and good up to 300 PSI.  Fabric braid Nitrile cover -40°F to 212°F
1/2" ID	18	9.802-259.0	190 °F	300		
3/4" ID	19	9.802-261.0	190 °F	300		
<b>Vinyl tubing</b>						
1/4" x 1/2"	20	9.802-251.0	50 °F			Clear vinyl / ft. - available by the foot or in 100' rolls
1/4" x 1/2"	21	9.802-252.0	250 °F			Braided vinyl / ft. - available by the foot or in 100' rolls

## HOSE REELS AND BRACKETS



		Order no.	Length (ft.)	Description
<b>Ready-Stack hose reels</b>				
Ready-Stack hose reels	1	9.801-763.0 ■	100	Mild steel, 6000 PSI, 350°F
	2	9.801-764.0 ■	200	Mild steel, 6000 PSI, 350°F
	3	9.801-765.0 ■	100	Stainless Steel, 6000 PSI, 350°F
	4	9.801-766.0 ■	200	Stainless Steel, 6000 PSI, 350°F
	5	8.923-415.0 ■	100	Hose Guide for 100 Ft Reel
	6	8.923-427.0 ■	200	Hose Guide for 200 Ft Reel
	7	8.923-416.0 ■		Hose Reel Riser, feed hose over and around obstacles
	8	8.923-918.0 ■		Reel Cart System, easily move multiple hoses and reels where needed.
<b>Automatic, self-winding hose reels</b>				
Self-winding hose reel	9	2.639-919.0	66	For wall mounting of high-pressure hose. Hose and bracket (2.639-931.0)sold separately.
Swivel wall mount bracket	10	2.639-931.0		
<b>Manual hose reels</b>				
HD Classic hose reel	11	9.801-253.0		Non-pivoting with mounting kit for HD gas series. 4000 PSI, 225° F, connects to standard 22 mm high-pressure hose. Hose sold separately.
Jumper hose	12	9.162-154.0		
Fixed Based	13	8.750-682.0	100	5000 PSI, 325° F, equipped for 3/8" hose. 2-year warranty.
Pivot Reel	14	8.750-685.0	100	5000 PSI, 325° F, equipped for 3/8" hose. 2-year warranty.
Fixed Based	15	8.750-683.0	200	5000 PSI, 325° F, equipped for 3/8" hose. 2-year warranty.
Pivot Reel	16	8.750-684.0	100	5000 PSI, 325° F, equipped for 3/8" hose. 2-year warranty.
Pivot Reel, Trailer Mount	17	8.920-146.0		
Pivot Reel, Trailer Mount	18	8.920-147.0		
<b>Hose reel brackets</b>				
Mounting kit for HDS full size units	19	9.801-418.0		Hose sold separately.
Trailer Mount Support, Pivot Reels	20	8.920-127.0	33	
Universal Mount	21	8.919-430.0	50	
Skid Mount	22	8.919-794.0	100	
Wall Mount	23	8.919-437.0	50	
Base Mount	24	8.919-434.0		
Bracket, Universal	25	8.919-072.0		
Bracket, 90°	26	8.919-445.0		
Bracket, 45°	27	8.919-441.0		
Bracket, Vertical	24	8.919-448.0		

■ NEW

# HOSE REEL SWIVELS



		Order no.	Description
<b>Hose reel swivels</b>			
1/2" M x 3/8" F	1	9.118-021.0	5000 PSI, stainless steel rotor, unique dual seal for extra long life. 2-year warranty.
1/2" F x 3/8" F	2	9.118-022.0	
3/8" M x 3/8" F	3	9.118-023.0	
3/8" F x 3/8" F	4	9.118-024.0	
1/2" M x 1/2" F	5	9.118-025.0	
1/2" F x 1/2" F	6	9.118-026.0	
3/8" M x 1/2" F	7	9.118-027.0	
3/8" F x 1/2" F	8	9.118-028.0	
1/2" M x 3/8" F	9	9.118-020.0	Extended swivels - protects hose and limits bend and hose stress
1/2" F x 3/8" F	10	9.118-029.0	
3/8" M x 3/8" F	11	9.118-030.0	
3/8" F x 3/8" F	12	9.118-031.0	
3/8" F x 1/2" F	13	9.118-032.0	
3/8" M x 1/2" F	14	9.118-033.0	
1/2" F x 1/2" F	15	9.118-034.0	
1/2" M x 1/2" F	16	9.118-035.0	



# COUPLINGS



		Order no.	Description
<b>Rotary coupling</b>			
Rotary coupling	1	4.401-091.0	Prevents twisting of high-pressure hoses. Grip protection.
22 mm Rotary Hose Connector	2	4.401-076.0	
22 mm x 3/8 FPT		9.802-175.0	
<b>Hose Coupling</b>			
Combines two 22 mm HP Hoses	3	4.403-002.0	For connecting and extending two high-pressure hoses. Brass with rubber protector.
Large Washer		6.362-124.0	
Small Washer		5.364-129.0	
<b>Hose Coupling</b>			
Nozzle screws/screw socket	4	4.402-022.0	For attaching high-pressure nozzles and accessories to the trigger gun (with nozzle connector), 1 x M 22 x 1.5 / 1 x M 18 x 1.5.

# WASH BRUSHES



		Order no.	Flow rate	Description
<b>Push-on wash brush</b>				
Push-on wash brush	5	4.762-016.0		For use with hot or cold water Classic machines. Clamps directly onto 18 mm spray lance.
Push-on wash brush	6	4.762-444.0		For use with cold water Classic machines. Mounts onto double or triple nozzles.
<b>Rotating wash brush</b>				
Rotating wash brush	7	4.762-559.0	4 GPM an up	Nylon bristles. Driven by water jet, gently removes fine dust and traffic film from all surfaces.
Rotating wash brush	8	4.762-561.0	up to 4 GPM	
Rotating wash brush	9	4.762-562.0	4 GPM an up	Natural bristles. Driven by water jet, gently removes fine dust and traffic film from all surfaces.
Rotating wash brush	10	4.762-560.0	up to 4 GPM	

# TRIGGER GUNS



The new Kärcher HP quick coupling allows quick and easy replacement of a wide variety of accessories and is ideal for Kärcher high-pressure trigger guns, servo-control controllers and spray pipes. Kärcher EASY Press hand spray guns impress with their patented holding force reduction and the Soft Grip insert for comfortable gripping. The servo control controller on the grip ensures precise, convenient regulation of pressure and water flow during operation.

		<b>Order no.</b>	<b>Flow rate</b>	<b>Description</b>
<b>Easy Press high-pressure gun with holding power reduction (Kärcher patent)</b>				
Easy press trigger gun with soft grip	1	4.775-466.0		Easy Press Trigger Gun, ID 8, 22 mm screw-type connection.
Easy press trigger gun with soft grip	2	4.775-463.0		ID 8, Integrated AVS Connection.
<b>Servo Control</b>				
Servo control	3	4.775-526.0	Less than 3.3 GPM	
	4	4.775-471.0	Greater than 4.9 GPM	
	5	4.775-470.0	3.3 to 4.9 GPM	
<b>Trigger guns</b>				
Trigger Gun	6	4.775-539.0		ID 8, 22 mm connection
Extended Trigger Gun	7	4.775-298.0		ID 6, Integrated AVS hose connection, without pressure gauge
Extended Softgrip Trigger Gun	8	4.775-529.0		Extended Soft-grip Trigger Gun, ID 6, Integrated AVS hose connection
Soft-grip Trigger Gun Replacement	9	4.775-080.0		Soft-grip Trigger Gun Replacement, ID 6, Integral AVS hose connection
Extended Trigger Gun	10	9.112-009.0		Extended Trigger Gun, 22 mm Male / Male Connectors (used on newer Classic HD direct drive units)
Extended Trigger Gun	11	9.112-017.0		Extended Trigger Gun, 22 mm Female Wand / Male hose connectors (used on HD gas units)



		Order no.	Description
<b>Quick connect</b>			
Quick Disconnect	12	6.401-458.0	
22 mm x 1/4" quick coupler	13	9.154-045.0	
18 mm x 1/4" quick coupler	14	9.841-659.0	
Hardened stainless steel nipple for coupler	15	6.401.459.0	
<b>Trigger gun repair kits</b>			
Trigger gun repair kit	16	2.880-369.0	for 4.775-041.0
	17	2.880-173.0	for 4.775-012.0; 4.775-010.0 /-015.0 / -017.0 /
	18	2.880-463.0	for 4.775-056.0
	19	2.883-191.0	for 4.775-079.0
	20	2.883-192.0	for 4.775-080.0
	21	2.883-888.0	For 4.775-254.0

# SPRAY WANDS



Kärcher standard high-quality stainless steel spray wands, available in various lengths, can be rotated 360° while under pressure. They feature ergonomically shaped grips and large couplings for easy use and insulation. Special spray lances significantly extend the range of uses of high-pressure cleaners.

		Order no.	Max working pressure	Length	Description
<b>Non-pivoting spray wand</b>					
Non-pivoting spray wand	1	4.760-667.0		10" / 250 mm	Stainless steel with manual coupling. With extended trigger gun.
	2	4.760-665.0		21" / 550 mm	
Spray wand	3	9.112-508.0		21" / 550 mm	w/ Quick Connect Female Threads
	4	9.802-220.0		21" / 550 mm	w/ Quick Connect Male Threads
<b>Pivoting spray wand</b>					
Pivoting spray wand	5	4.760-664.0	4350	24" / 600 mm	Spray pipes in different lengths, stainless steel with large manual coupling. Ergonomic handles ensure optimal handling and protection. Rotatable under pressure by 360°.
	6	4.760-663.0	4350	33.5" / 850 mm	
	7	4.760-584.0	4350	41" / 1050 mm	
	8	4.760-661.0	4350	61" / 1550 mm	
	9	4.760-662.0	4350	81" / 2050 mm	
	10	4.760-691.0	4350	24" / 600 mm	
11	4.760-609.0	4350	81" / 2050 mm		
<b>Variable pressure spray wand</b>					
Variable pressure spray wand	12	4.760-362.0	4000	26" / 670 mm	With integral pressure gauge for infinitely variable pressure control on wand, nozzle connection 24 mm x 1.5, chemical feed in low-pressure mode.
Adapter	13	4.762-075.0			For attaching accessories to variable pressure wand.
<b>Specialty wands</b>					
Washroom and gutter wand	14	4.760-073.0	4000		With nozzle insert. Specially shaped for cleaning gutters and hygienically cleaning wash rooms. Stainless steel
Underbody spray wand	15	4.760.245.0	4000	27" / 700 mm	Mobile; for convenient and effective cleaning of vehicle underbodies and wheel arches. Stainless steel. Nozzle sold separately.
Gutter cleaning wand	16	2.642-305.0	4000		This spray wand is designed for cleaning gutter drainage systems. The wand shape and the special nozzle allow cleaning to be carried out without removing the cover screen.



	Order no.	Description
<b>O-ring kits</b> For use on Kärcher guns, wands, nozzles and more.	2.880-154.0	O-rings package of 3
	2.880-296.0	O-rings package of 5
	2.880-208.0	O-rings package of 20
	2.880-168.0	O-rings package of 100
	2.880-292.0	O-rings for Swivel Connections, (5-pack: 2 swivel, 3 std)

## NOZZLES AND POWER NOZZLES

The Kärcher Power Nozzle, developed and patented by Kärcher, offers a performance that is distinctly better than that of conventional nozzles.

The concentrated spray jet of large coherent droplets is sharp-contoured and increases impact pressure by up to 40%. This produces a considerable improvement in cleaning efficiency.

Assuming the same degree of soiling, the Power Nozzle cleans at a much faster rate and, an environmentally friendly benefit, uses less water and cleaning agent.

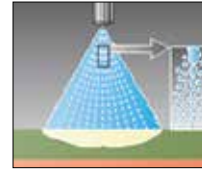

The Power Nozzle's spray jet cleans with the same high-impact pressure over its whole working width. This provides substantially more cleaning power for a given amount of energy.

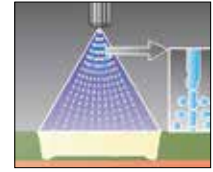

Regular nozzle



Power nozzle

		Order no.	Nozzle size	Description
<b>Nozzle adapter</b>				
Nozzle adapter	1	9.315-002.0		18 mm x 1/4" female. For connecting Kärcher nozzles to non-Kärcher wands.
<b>Nozzle spray angle 0°</b>				
High-pressure nozzle spray angle 0°  	2	2.884-533.0	040	Solid jet for removing extremely stubborn dirt.
	3	2.884-534.0	045	
	4	2.884-535.0	050	
	5	2.884-536.0	055	
	6	2.884-537.0	060	
	7	2.884-540.0	075	
	8	2.884-541.0	80	
	9	2.884-544.0	110	
	<b>Power nozzle spray angle 15°</b>			
Power nozzle spray angle 15°  	10	2.883-388.0	040	Flat stream for stubborn contaminations.
	11	2.883-389.0	045	
	12	2.883-390.0	055	
	13	2.883-391.0	060	
	14	2.883-392.0	070	
	15	2.883-393.0	075	
	16	2.883-394.0	080	
	17	2.883-396.0	100	

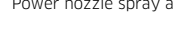

		Order no.	Nozzle size	Description
<b>Power nozzle spray angle 25°</b>				
 <p>Power nozzle spray angle 25°</p>	18	2.883-803.0	034	Fan jet nozzle for large area coverage and tackling dirt and stains.
	19	2.883-821.0	036	Fan jet nozzle for large area coverage and stubborn dirt and contaminations.
	20	2.883-805.0	038	Fan jet nozzle for large area coverage and tackling stubborn dirt and stains.
	21	2.883-397.0	040	
	22	2.883-829.0	043	
	23	2.883-398.0	045	
	24	2.883-399.0	050	
	25	2.883-400.0	052	
	26	2.883-403.0	065	
	27	2.885-133.0	068	
	28	2.883-404.0	070	
	29	2.883-926.0	072	
	30	2.883-785.0	110	
31	2.885-157.0	155		
<b>Power nozzle spray angle 40°</b>				
 <p>Power nozzle spray angle 40°</p>	32	2.884-522.0	040	Fan jet for high area performance - suitable for sensitive surfaces.
	33	2.884-523.0	045	
	34	2.884-524.0	050	
	35	2.884-525.0	055	
	36	2.884-526.0	075	
	37	2.884-527.0	080	

## TRIPLE NOZZLES



Kärcher triple nozzles combine quality, flexibility and cleaning power. The robust and high-quality stainless steel nozzle guarantees a long service life. Choose one of three spray types: 0° high-pressure pencil jet, 25° high-pressure fan jet and 40° low-pressure jet (with cleaning agent suction). The integrated power nozzle contour in the 25° high-pressure fan jet guarantees maximum cleaning power. With the touchless triple nozzle, changeover between 0° pencil jet and 25° fan jet is especially convenient, by simply turning the spray lance.

		Order no.	Max working pressure	Nozzle size	Description
<b>Triple nozzles</b>					
Triple nozzle 028	1	4.767-144.0	4350 PSI	028	Manually selectable triple nozzle with stainless steel nozzle. Robust, durable and non-clogging. Convenient selection of high-pressure pencil jet (0°), high-pressure fan jet with power nozzle (25°) and low-pressure fan jet (40°). For high-pressure cleaners with hs; low-pressure fan jet for cleaning agent removal and application. M 18 x 1.5 connection.
Triple nozzle 030	2	4.767-190.0	4350 PSI	030	
Triple nozzle 031	3	4.767-145.0	4350 PSI	031	
Triple nozzle 032	4	4.767-195.0	4350 PSI	032	
Triple nozzle 033	5	4.767-146.0	4350 PSI	033	
Triple nozzle 034	6	4.767-147.0	4350 PSI	034	
Triple nozzle 036	7	4.767-148.0	4350 PSI	036	
Triple nozzle 038	8	4.767-149.0	4350 PSI	038	
Triple nozzle 040	9	4.767-150.0	4350 PSI	040	
Triple nozzle 042	10	4.767-151.0	4350 PSI	042	
Triple nozzle 043	11	4.767-152.0	4350 PSI	043	
Triple jet nozzle 045	12	4.767-153.0	4350 PSI	045	
Triple nozzle 050	13	4.767-154.0	4350 PSI	050	
Triple nozzle 053	14	4.767-155.0	4350 PSI	053	
Triple nozzle 055	15	4.767-156.0	4350 PSI	055	
Triple jet nozzle 060	16	4.767-157.0	4350 PSI	060	
<b>Triple nozzle, touchless changeover</b>					
Triple nozzle, touchless changeover	17	4.767-001.0	4350 PSI	034	Fast and easy jet changeover by flicking the nozzle. Choice of high-pressure pencil jet or high-pressure fan jet (25°), with manual changeover to low-pressure fan jet (40°). For high-pressure cleaners with injectors; low-pressure fan jet for cleaning agent removal and application. M 18 x 1.5 connection.
	18	4.767-016.0	4350 PSI	037	
	19	4.767-065.0	4350 PSI	050	
	20	4.767-066.0	4350 PSI	055	
	21	4.767-067.0	4350 PSI	060	
	22	4.767-068.0	4350 PSI	080	
	22	4.767-069.0	4350 PSI	120	





		Order no.	Max working pressure	Nozzle size	Description
<b>Angle vario nozzle 0°-90°</b>					
Angle vario nozzle 0°-90°	23	4.763-039.0	4350 PSI	050	Allows variable adjustment of the high-pressure jet spray angle from 0-90°. This allows easy adaptation to all types of contaminations and surfaces.
	24	4.763-058.0	4350 PSI	055	
	25	4.763-036.0	4350 PSI	080	
<b>Changeover nozzles</b>					
Double changeover nozzles	26	4.764-177.0	4350 PSI	031, 0° and 25°	
	27	4.763-091.0	4350 PSI	050, 0° and 25°	
	28	4.763-151.0	4350 PSI	040, 0° and 25°	
Triple changeover nozzles	29	4.767-196.0	4350 PSI	031	
	30	4.767-197.0	4350 PSI	034	
	31	4.767-198.0	4350 PSI	040	
	32	4.767-199.0	4350 PSI	045	
	33	4.767-200.0	4350 PSI	050	
34	4.767-201.0	4350 PSI	055		

## ROTARY NOZZLES



The Kärcher dirt blaster combines the advantages of pencil jets and fan jets. The nozzle spins at approximately 4,000 rpm to apply a powerful cleaning spray to a large area.



Rotating  
pencil jet



Pencil jet



Fan jet

		Order no.	Max working pressure	Nozzle size	Description
<b>Dirt Blaster - more performance</b>					
Dirt Blaster	1	4.767-229.0 ■	2600 PSI	030	Dirt Blaster - rotating pencil jet - 10 times the cleaning power . Highest Stand Ceramic nozzle / nozzle and bearing ring . Max . 180 bar / 18 MPa , 60° C.  <b>Increased cleaning power; 50% more performance.</b>
	2	4.767-230.0 ■	2600 PSI	035	
	3	4.767-231.0 ■	2600 PSI	040	
	4	4.767-232.0 ■	2600 PSI	045	
	5	4.767-233.0 ■	2600 PSI	050	
<b>Dirt Blaster, small</b>					
Dirt Blaster	6	4.767-041.0	2600 PSI	030	Dirt blaster - rotating point jet - 10 times the cleaning performance. Ceramic nozzle / bearing ring provides long service life. Max. 180 bar / 18 MPa, 60 °C.
	7	4.767-022.0	2600 PSI	035	
	8	4.767-023.0	2600 PSI	040	
	9	4.767-100.0	2600 PSI	045	
	10	4.767-024.0	2600 PSI	050	
<b>Dirt Blaster, large</b>					
Dirt Blaster	11	9.302-447.0	4350 PSI	035	Dirt blaster - rotating point jet - 10 times the cleaning performance. Ceramic nozzle / bearing ring provides long service life. Max. 180 bar / 18 MPa, 60 °C.
	12	9.302-443.0	4350 PSI	040	
	13	9.302-448.0	4350 PSI	045	
	14	9.302-444.0	4350 PSI	050	
	15	9.302-442.0	4350 PSI	055/060	
	16	9.302-449.0	4350 PSI	065	
	17	9.302-445.0	4350 PSI	070/080	
	18	9.302-446.0	4350 PSI	100	
<b>Quick connect</b>					
Quick connect	19	9.154-023.0	2600 PSI		Convert from screw-connect to Quick Connect 18 mm
<b>Dirt Blaster filter</b>					
Dirt Blaster filter	20	4.730-032.0			

■ NEW



		Order no.	Max working pressure	Nozzle size	Description
<b>Dirt Blaster - changeover series, high-pressure</b>					
Dirt Blaster - changeover series, high-pressure	21	4.763-956.0	4300 PSI	040	Changeover to high-pressure fan jet. Max temp 185° F / 85° C.
	22	4.763-957.0	4300 PSI	050	
	23	4.763-955.0	4300 PSI	055/060	
	24	4.763-958.0	4300 PSI	070/080	
<b>Dirt Blaster - changeover series, chemical</b>					
Dirt Blaster - changeover series, chemical	25	4.763-950.0	4300 PSI	040	Changeover to low-pressure chemical nozzle. Max temp 185° F / 85° C.
	26	4.763-951.0	4300 PSI	050	
	27	4.763-949.0	4300 PSI	055/060	
	28	4.763-952.0	4300 PSI	070/080	
<b>Dirt Blaster repair kits</b>					
Dirt Blaster repair kits	29	2.883-473.0			055/060
	30	2.883-471.0			040
	31	2.883-472.0			050
	32	2.883-474.0			070/080
	33	9.302-231.0			045
	34	2.884-114.0			065
	36	2.884-051.0			100
	37	2.884-051.0			120
	38	2.884-052.0			035
	39	2.883-810.0			4.763-949/-955
	40	2.883-811.0			4.763-950/-956
	41	2.883-813.0			4.763-952/-958
	42	2.884-113.0			4.763-988.0
	43	2.884-114.0			4.763-989.0

## STEAM JET NOZZLES



		Order no.	Nozzle size	Description
<b>Steam nozzle</b>				
Steam jet nozzle	1	4.766-023.0	050	50° fan jet for cleaning and thawing in steam mode, e.g. thawing sand and gravel, de-icing form work, dewaxing vehicles.
	2	4.766-024.0	055	
	3	2.885-039.0	065	
	4	2.885-119.0	070	
	5	2.885-049.0	090	
	6	2.885-041.0	045	
	7	2.885-147.0	050	
<b>Nozzle protector for steam nozzle</b>				
Nozzle protector (rubber)	8	5.394-059.0		Nozzle protection for steam jet nozzles 4.766-023.0 and 4.766-024.0.
<b>Dual nozzle holder</b>				
Dual nozzle holder	9	4.764-012.0		Dual nozzle holder
<b>Nozzle union</b>				
Nozzle connector	10	5.401-210.0		With protector for high-pressure and power nozzles M 18 x 1.5.
<b>Spacer (including nozzle union)</b>				
Spacer (incl. nozzle union)	11	5.394-294.0		Spacer with nozzle connector - fits 18 mm wand connections

# PIPE CLEANING



		Order no.	Max working pressure	Nozzle size	Diameter	Description
<b>Pipe cleaning hose</b>						
Pipe cleaning hose, ID 6, 20 m, 66 ft.	1	6.390-028.0	1740 PSI			Extremely flexible high-pressure-hose for cleaning inside pipes (threaded connection for R 1/8 nozzle).
Pipe cleaning hose, ID 6, 30 m, 100 ft.	2	6.390-029.0	1740 PSI			
Pipe cleaning hose, ID 6, 20 m, 66 ft.	3	6.390-030.0	2900 PSI			
<b>Pipe cleaning nozzles</b>						
Pipe cleaning nozzle, 1" D 25 / 040	4	6.415-944.0 ■		040	25 mm	With R - 1/8" connector for mounting on the pipe cleaning hose . 1 x rotary nozzle forwards, 3 x 30° backwards.
Pipe cleaning dirt blaster 1.8"	5	6.415-946.0 ■		040	30 mm	
Pipe cleaning dirt blaster 1.4"	6	6.415-948.0 ■		040	35 mm	
Pipe cleaning nozzle 3 x 30° backwards	7	5.763-015.0		055	16 mm	With R 1/8" fitting for attachment to pipe cleaning hose.
	8	5.763-019.0		065	16 mm	
	9	5.763-017.0		050	30 mm	
	10	5.763-021.0		070	30 mm	
Pipe cleaning nozzle 1 x forward, 3 x 30° backwards	11	5.763-016.0		060	16 mm	With R 1/8" fitting for attachment to pipe cleaning hose.
	12	5.763-020.0		065	16 mm	
<b>Rotating jets</b>						
4 rotating jets	13	6.415-428.0		050	16 mm	With R 1/8" fitting for attachment to pipe cleaning hose.
	14	6.415-440.0		065	16 mm	
<b>Brass nozzles - direct connections to 22 mm high-pressure hose</b>						
Brass nozzles - direct connections to 22 mm high-pressure hose	15	5.763-011.0				Brass nozzle, 830 PSI / 3.5 GPM - direct connects to 22 mm
	16	5.763-013.0				Brass nozzle, 800 PSI / 5.3 GPM - direct connects to 22 mm
<b>Pipe cleaning stop valve</b>						
Pipe cleaning stop valve	17	4.580-160.0				Mounts to machine's high-pressure outlet, simplifies handling of pipe cleaning hose because on-off functions can be easily controlled on the machine. Direct connection to 22 mm high pressure hose.

■ NEW

# SURFACE CLEANERS

Surface cleaners offer a massive area performance and clean without splashing. They come with a plastic and stainless steel hood for hot water cleaning applications.

		<b>Order no.</b>	<b>Flow rate</b>	<b>Diameter</b>	<b>Description</b>
<b>Surface Cleaner FR Classic</b>					
Surface Cleaner FR Classic - nozzles sold separately	1	2.643-476.0 ■		12"	The entry-level model of Kärcher Hard surface cleaner for the splash-proof cleaning of surfaces in indoor and outdoor applications. Nozzle kit has to be ordered separately. Max. 150 bar / 600 l / h / 40 °C .
<b>Surface Cleaner FR Basic</b>					
Surface Cleaner FR Basic - includes nozzle kit	2	2.643-494.0 ■		12"	The entry-level model of Kärcher Hard surface cleaner for the splash-proof cleaning of surfaces in indoor and outdoor applications . Plastic housing and simple ceramic bearing. Nozzle kit included. Max. 180 bar / 600 l / h / 60 °C .
<b>Hard surface cleaner FR 30 Me</b>					
Hard surface cleaner FR 30 Me - nozzles sold separately	3	2.640-355.0		12"	The FR 30 Me hard surface cleaner is an indispensable accessory for efficient and economical professional cleaning – both indoor and outdoor. Rotating Power Nozzles, protected by a stainless steel housing, boost your cleaning coverage area by a factor of 10!
Hard surface cleaner FR 30 Me with Power Nozzles	4	2.640-447.0	2.2-2.9 GPM	12"	With the FR 30 Me, you save time and achieve perfectly uniform results without splashing or getting wet. Equipped with an integrated vacuum connection, the FR 30 Me is ideal for cleaning indoor areas that would be impractical with other surface cleaners. Wall cleaning is just as convenient thanks to ergonomic handles and direct connection to a trigger gun. Use with both cold and hot water pressure washers. The versatility of the FR 30 Me is appreciated in workshops and industrial kitchens, as well as by contract cleaners and municipalities. Comes standard with adapter to fit non-Kärcher wands.
Hard surface cleaner FR 30 Me with Power Nozzles	5	2.640-448.0	2.9-4.0 GPM	12"	
Hard surface cleaner FR 30 Me with Power Nozzles	6	2.640-449.0	4.0-4.9 GPM	12"	Maximum pressure: 3625 PSI Max temperature: 175° F
<b>Hard surface cleaner FR 50</b>					
Hard surface cleaner FR 50	7	2.640-679.0		20"	With a 20" cleaning area, the FR 50 provides a greatly increased coverage area to make quick work of bigger cleaning jobs. The rotating nozzle beam has a swivel joint with ceramic bearings, and is built with a durable rust-free stainless steel housing that connects directly to standard Kärcher trigger guns. The unit's handle design and three non-marking casters ensure easy operation. Detergents can be added through a low pressure valve. Use with Kärcher Power Nozzles (sold separately) for the most thorough and uniform cleaning possible.  Maximum pressure: 3625 PSI Max temperature: 175° F
<b>Machine-specific nozzle kit for FR</b>					
Nozzle packet for surface cleaners nozzles sold separately	8	2.640-482.0	1.9-2.1 GPM		Unit specific nozzle kit: Kärcher power nozzle for surface cleaners.
	9	2.640-401.0	2.2-2.9 GPM		
	10	2.639-187.0	2.9-4.0 GPM		
	11	2.640-442.0	4.0-4.9 GPM		
	12	2.639-188.0	4.8-5.7 GPM		
	13	2.640-781.0	5.7-7.9 GPM		
	14	2.640-282.0	8.0-9.7 GPM		
<b>Adapters</b>					
Adaptor for non-Kärcher wands	15	9.369-012.0			
Adaptor to connect gun directly to FR 30	16	4.402-022.0			

■ NEW

## SURFACE CLEANERS WITH SUCTION



		<b>Order no.</b>	<b>Flow rate</b>	<b>Diameter</b>	<b>Description</b>
<b>Hard surface cleaner FRV 30</b>					
Hard surface cleaner FRV 30 - nozzles sold separately	17	2.642-999.0		12"	FRV 30 with integrated, automatic dirty water pickup makes cleaning even more efficient - suitable for indoor and outdoor use. Rinsing after cleaning is unnecessary as the dirty water can be conveniently removed with the supplied 5 m suction hose. Non-marking swivel castors and double ceramic bearings are further quality features. Order unit-specific nozzle kit separately.
Extension hose	18	4.440-939.0			5 m, includes adapter
Adapter	19	4.402-022.0			18 mm x 22 mm Adaptor to connect gun directly to FR30
Dirt Trap	20	2.642-532.0			Galvanized steel bucket for collecting coarse dirt and for fixing the suction hose in outside areas.
Suction cup kit for extension hose	21	2.642-528.0			Suction cup for fixing the suction hose to smooth surfaces.
<b>Hard surface cleaner FRV 30 Me</b>					
Hard surface cleaner FRV 30 Me - nozzles sold separately	22	2.642-911.0		12"	With the integrated, automatic suction of the wastewater, the FRV 30 Me makes surface cleaning more efficient and allows use indoors and outdoors. The stainless steel design of the renowned FRV 30 allows cleaning with hot water up to 85 °C. The FRV 30 Me features a temperature-resistant 7.5 m polyurethane suction hose. It also features non-marking steering rollers and double ceramic bearings. Machine-specific nozzle kit must be ordered separately. Max. 250 bar / 1,300 l/h / 85 °C.
Extension hose	23	4.441-040.0			Extension suction hose, 16' with coupling (fits FRV 30 Me)
<b>Machine-specific nozzle kit for FRV</b>					
Nozzle packet for surface cleaners nozzles sold separately	24	2.642-430.0	1.9-2.1 GPM		Unit specific nozzle kit: Kärcher power nozzles and venturi nozzle for FRV 30.
	25	2.642-431.0	2.2-2.9 GPM		
	26	2.642-432.0	2.9-4.0 GPM		
	27	2.642-433.0	4.0-4.9 GPM		

# WET BLASTING ATTACHMENTS



The wet blasting attachment fits easily on Kärcher high-pressure cleaner spray wands. The abrasive is sucked up into the water jet and applied with a powerful abrasive action. Ideal for removing rust, scale and paint from components as well as graffiti.



		Order no.	Nozzle size	Description
<b>Wet blasting attachment (without nozzle)</b>				
Wet blasting attachment with flow control (without nozzles)	1	4.762-010.0		Adds abrasive to high-pressure jet. For removing paint, rust, scaling. Fits on spray lance in place of HP nozzle. With flow control.
Wet blasting attachment without flow control (nozzles not included)	2	4.762-022.0		Adds abrasive to high-pressure jet. For removing paint, rust, scaling. Fits on spray lance in place of HP nozzle. Without flow control.
<b>Nozzle pack for wet blasting attachment</b>				
Nozzle kit for wet blasting attachment	3	2.638-526.0	035	Consisting of wet blasting nozzle and nozzle insert - use in conjunction with wet blasting attachment (4.762-010.0 / -022.0)
	4	2.637-900.0	040	
	5	2.637-901.0	045	
	6	2.637-902.0	050	
	7	2.637-903.0	055	
	8	2.637-904.0	060	
	9	2.637-905.0	065	
Nozzle kit - sand nozzle only	10	5.769-011.0		
<b>Boron carbide nozzle</b>				
Boron carbide nozzle	11	6.415-084.0	6 mm	In addition to nozzle packs. Highly wear-resistant blasting nozzle with boron carbide lining for continuous use.
	12	6.415-083.0	8 mm	



# FOAM SYSTEMS AND CLEANING AGENT INJECTORS



		Order no.	Flow rate	Description
<b>Inno Foam kit</b>				
Inno Foam System, for models that dispense detergent at low pressure  (purchase nozzle insert separately)	1	2.640-151.0		Kärcher's complete, ready-to-use high pressure foaming system is a twin spray lance and precision chemical injection system. The patent-pending dual spray wand provides a multitude of functions for many washing applications.  Apply a thick layer of foam using the Inno foam nozzle, then switch easily to high pressure for clear rinsing. The dual wand can be equipped with your choice of high pressure nozzles.  The chemical injection system provides precise detergent metering (0-5% concentration), providing faster and more consistent results using the optimum amount of detergent.
Inno Foam System, for models that dispense detergent at high pressure  (purchase nozzle insert separately)	2	2.640-692.0		Wand Length: 25.6" Maximum Pressure: 3700 PSI Maximum Flow Rate: 5.8 GPM Maximum Temperature: 176°F
<b>Easy Foam Set</b>				
Easy Foam Set with RM injector	3	2.640-691.0		Easy Foam System, for models that dispense detergent at low pressure (purchase nozzle insert separately)
Easy Foam Set	4	2.640-693.0		Easy Foam System, for models that dispense detergent at high pressure (purchase nozzle insert separately)
<b>Foam Nozzle Inserts for Inno / Easy Sets</b>				
Foam nozzle inserts nozzles sold separately	5	2.640-870.0	2.2-2.6 GPM	Ideally match performance to different machine outputs for economic operation.
	6	2.640-687.0	2.7-3.0 GPM	
	7	2.640-688.0	3.1-4.4 GPM	
	8	2.640-689.0	4.5-5.8 GPM	
<b>Foam nozzle mounting kit</b>				
Foam nozzle attachment kit	9	2.637-926.0		For applying foam detergent in metered quantities in sanitary and food areas, or where long reaction time is needed. Fits all units and mounts to spray lance in place of HP nozzle.
<b>High-pressure detergent injector</b>				
High-Pressure Detergent Injector	10	3.637-170.0		Cleaning agent dosage at high-pressure 3-5%
Cleaning agent injector for high and low pressure (without nozzles, downstream)	11	3.637-001.0		Dosage of detergents. Separately from the machine in low and high pressure. Dosage up to 15%.
<b>Machine-specific nozzle kits with order no. 3.637-170</b>				
Nozzle Kit - HD units	12	4.769-045.0	2.2-3.0 GPM	
Nozzle Kit - HDS units	13	4.769-046.0	2.2-3.0 GPM	
Nozzle Kit - HD and HDS units	14	4.769-047.0	3.3-4.4 GPM	
Nozzle Kit - HD and HDS units	15	4.769-048.0	4.4-5.3 GPM	
<b>Machine-specific nozzle kits with order no. 3.637-001.0</b>				
High-pressure nozzle insert	16	4.769-003.0	up to 4.9 GPM	
High-pressure nozzle insert	17	4.769-002.0	4.9+ GPM	
Low-pressure nozzle insert	18	4.769-001.0	up to 4.9 GPM	
Low-pressure nozzle insert	19	4.769-006.0	4.9+ GPM	

## OTHER ACCESSORIES



			Order no.	Description
<b>Fine-mesh water filter</b>				
Fine-mesh water filter, 100 µm, R 3/4"	1	2.637-691.0		For connection to unit inlet, 100 µm.
Water fine filter, 90-120 µm, R 1"	2	2.638-255.0		Fits on unit, suitable for pressure and suction, 90-120 µm.
Fine-mesh water filter with adapter	3	4.730-102.0		Connects to unit, 125 µm, with R 3/4" / 1" adapter.
Fine-mesh water filter, 100 µm, R 1"	4	2.638-270.0		For connection to unit inlet, 100 µm.
<b>Suction filter</b>				
Suction filter with check valve	5	4.730-012.0		
HDS GHF x mm Screw Union	6	4.401-073.0		
HD GHF x mm Screw Union (plastic)	7	4.401-059.0		
18 mm (F) x 22 mm (M) Adapter	8	4.402-022.0		
22 mm x 3/8 QC	9	9.154-045.0		
<b>Flue pipe</b>				
4.75" (120 mm) outlet	10	4.656-149.0		HDS 1.7/12 U Ed; HDS Compact; HDS 1000 BE/DE; HDS Mid-Class (2005-2011)
6.25" (158 mm) outlet	11	4.656-079.0		HDS Full Size Units
7.9" (200 mm) outlet	12	4.656-080.0		HDS 1.7/12 U Ed; HDS
8", 12V DC, Barometric Dampener	13	8.717-764.0		
10", 12V DC, Power Dampener	14	8.749-806.0		
12", 12V DC, Power Dampener	15	8.753-171.0		
8", Round	16	8.717-728.0		
10", Round	17	9.801-040.0		
12", Round	18	8.717-730.0		
10", Exhaust Stack, Cap	19	8.717-731.0		
12", Exhaust Stack, Cap	20	8.717-732.0		
8" without Stack, new style kit	21	8.903-430.0		
8" without Stack, new style	22	8.717-745.0		
<b>Detergent injectors</b>				
Injector, 1-2 GPM, 0.057	23	8.709-404.0		Brass Housing with Stainless Steel nipple
Injector, 2-3 GPM, 0.070	24	9.802-215.0		3500 or 5000 PSI
Injector, 3-5 GPM, 0.083	25	9.802-216.0		Non-Adjustable Metering Viton Seals
Injector, 3-5 GPM, 0.083, 5,000 PSI	26	9.802-217.0		Rated up to 190°F/ 88°C
Injector Assembly, 1-2 GPM, 0.057	27	8.904-464.0		3/8" Q/C Inlet/Outlet
Injector Assembly, 2-3 GPM, 0.070	28	8.929-062.0		
Injector Assembly, 3-5 GPM, 0.083	29	9.802-225.0		
Injector Assembly, 3-5 GPM, 5,000 PSI	30	9.802-226.0		
Injector Repair Kit	31	8.704-199.0		



		Order no.	Description
<b>Voltage regulator</b>			
25 Amp, 15 Volt	1	9.802-531.0	
<b>Switches</b>			
Reed switch - HDS Compact Range	2	2.883-477.0	HDS 1.7/12 U Ed; HDS 500 Ci; HDS 600 Ci; HDS 900 Ci
Reed switch - HDS Classic Full Size	3	2.880-000.0	(2005-2011)
Reed switch - HDS Classic Skids	4	2.880-194.0	HDS 1000 BE/DE; HDS 801 B; HDS 745; HDS 895; HDS 945; HDS 1000; HDS 1055; HDS 1195
Reed switch - HDS Classic Full Size	5	2.885-240.0	(2012 Forward)
On/off rotary switch, 115-230V	6	9.802-449.0	1PH 3-position
On/off rotary switch, 230/460V	7	8.716-027.0	3PH 3-position
On/off rotary switch, 120-600V	8	9.802-450.0	1-3PH 2-position
Adjustable thermostat switch/discharge	9	8.750-094.0	150°C/302°F, 2 meter capillary
Adjustable thermostat switch/discharge	10	8.750-095.0	120°C/240°F, 2 meter capillary
Adjustable thermostat switch, 300°	11	9.802-285.0	
Adjustable thermostat switch, 175°	12	8.712-186.0	
<b>Kärcher 500 flow switch</b>			
Vertical mount only	13	8.712-244.0	Tough, impact-resistant, glass-reinforced, nylon housing. Tungsten contact reed switch. Heavy-duty machine brass internals. Viton seals. For solenoid control only.1-8 GPM. 4350 PSI. 3/8" FPT Inlet / Outlet. 190°F. 1 Amp switch. 2 Wire Reed. 63" wire length.
Mount in any position (gray)	14	8.933-006.0	
Reed switch only (2-wire)	15	9.803-266.0	
<b>Float tanks</b>			
NG/LPG Float Tank, Universal Plastic Float Tank	16	9.802-084.0	3.5 gallon capacity. 22" x 13-1/2" x 5". Heavy 3/16" durable plastic. Convenient mounting tabs.
Lid & Hinges for 9.802-084.0	17	8.912-233.0	
<b>Fuel tanks</b>			
Fuel Tank, 5 Gallon Black	18	9.802-079.0	Rugged fill neck cap with vent
Fuel Tank, 6 Gallon Black	19	9.802-081.0	
Fuel Tank, 8 Gallon Black	20	8.706-615.0	
Fuel Tank, 9 Gallon Black	21	9.802-089.0	
<b>Fuel caps</b>			
Cap, 14" w/Fuel Gauge, Red	22	9.803-536.0	
Cap, 14" w/Fuel Gauge, Black	23	9.803-535.0	
<b>Plastic dip tube assembly</b>			
Diptube, Plastic, 10" HDS Classic Skid	24	9.803-531.0	
Diptube, rubber bushing	25	9.802-053.0	

## AXIAL PUMPS, REPAIR KITS AND TOOLS



Kärcher's commercial-duty 3-piston axial pumps are simple, efficient, and very reliable and have fewer moving parts compared to crank-case and piston type pumps.

These proprietary pumps are engineered for long life with features like brass cylinder heads, ceramic pistons, and stainless steel valves. Kärcher's combined pump/motor units run cooler due to their unique water cooled design. And they use less power thanks to a unique drive center and wobble plate design.

Kärcher pumps feature a soft-dampening system to reduce pulsations in the high pressure system, increasing the service life of high pressure components.

	Order no.	Shaft	GPM	PSI	RPM
<b>Kärcher axial pumps</b>					
	9.120-021.0	3/4"	2.6	3000	3400
	9.120-020.0	5/8"	2.6	3000	3400
	9.120-019.0	1"	4.0	4000	3400
<b>Geared reduction for Kärcher pumps</b>					
	8.715-342.0	1" engine shaft, 24 mm pump shaft, 139.3 oz., 2.176:1 gear ratio, 11-18 hp.			
<b>Unloader valves</b>					
	9.802-362.0	PA VBB w/ switch (N/C)			
	9.803-899.0	VBA35 for Kärcher KG, KD, and KE pumps			
	8.715-508.0	VBXL 13 GPM @ 3000 PSI knob			
	8.712-589.0	MV520 for Kärcher KD and KE pumps			
	9.803-900.0	VBA35 for Kärcher KM and KS pumps			
	9.802-363.0	PA for Kärcher KM and LS pumps			
	9.802-361.0	VB55 w/ 1/8" Bore for Easy Start			
	8.715-502.0	HM DX Unset (921462)			
<b>Discharge manifold / rupture disk</b>					
Coil Outlet Discharge Manifold	9.149-003.0	Prevents dangerous thermal expansion of water in the coil and ensures operator safety.			
Rupture Disk, 8000 PSI, Red	8.725-944.0				
Rupture Disk, 5000 PSI, Blue	9.151-014.0				
Rupture Disk Spacer	9.184-030.0				
<b>Safety system pistons</b>					
Magnetic Pistons (HDS units to 2005)	4.553-022.0	Used for low-water protection.			
Brass Pistons (HDS 1000 BE/DE)	4.553-213.0				
<b>Pump installation tools</b>					
To press in valve seat (5.581-143.0) on HDS 745, 945, 1000, 1055, 1195.	2.901-036.0	12 mm			
	2.901-031.0	16 mm			
	2.901-033.0	18 mm			
	2.901-015.0	20 mm - HDS 801E, 945, 1090			
	2.901-018.0	22 mm - HDS 1195			
<b>Valve seat installation tool</b>					
HDS Classic Full Size - prior 2005; to press in valve seat	5.901-126.0	(5.581-143.0) on HDS 745, 945, 1000, 1055, 1195			
HDS Classic Full Size - 2005+; to press in valve seat	5.901-162.0	(5.581-143.0) on HDS 745, 945, 1000, 1055, 1195			
<b>Valve seat removal tool</b>					
	5.901-125.0	HDS Classic Full Size			
	5.901-161.0	HDS Classic - 2012			

	Pump kit	Model part no.
<b>HD electric models</b>		
HD 1.8/13 C Ed	2.883-997.0	1.514-111.0
HD 2.3/15 C Ed	2.883-997.0	1.150-611.0
HD 3.0/20 C Ea	2.883-997.0	1.150-610.0
HD 3.0/20-4M Ea	2.884-882.0	1.524-110.0
HD 3.5/30-4S Ea	2.883-902.0	1.286-110.0
HD 3.7/22-4S Eg	2.883-902.0	1.286-115.0
HD 4.5/32-4S Eb	2.883-902.0	1.286-112.0
HD 4.5/32-4S Ec	2.883-902.0	1.286-113.0
HD 5/12 C	2.883-997.0	1.514-106.0
HD 525 S	2.883-827.0	1.118-700.0
HD 651	2.883-869.0	1.150-110.0
HD 650	2.883-869.0	1.150-106.0
HD 655 S	2.883-286.0	1.902-405.0
HD 655 H	2.883-286.0	1.902-411.0
HD 655 H	2.883-286.0	1.902-412.0
HD 750	2.880-469.0	1.625-917.0
HD 760 WS	2.880-469.0	1.797-701.0
HD 850 S	2.880-469.0	1.877-681.0
HD 850 WS	2.880-469.0	1.754-701.0
HD 855 S	2.883-817.0	1.087-701.0
HD 1090	2.883-447.0	1.951-681.0
HD 10/25 S	2.883-902.0	1.286-105.0
<b>HD gas models</b>		
HD 2.5/24 P (vers 1)	2.884-214.0	1.575-105.0
HD 2.6/26 P (vers 1)	2.884-214.0	1.575-106.0
HD 4.0/36 P (vers 1)	2.884-217.0	1.575-108.0
HD 2500 G	2.884-215.0	1.194-112.0
HD 2500 MTD	2.884-215.0	1.194-114.0
HD 2600 DK	2.884-215.0	1.194-122.0
HD 2700 DB	2.884-215.0	1.194-116.0
HD 2700 DH	2.884-215.0	1.194-117.0
HD 2700 DH	2.884-215.0	1.194-123.0
HD 2700 DH Q/C	2.884-215.0	1.194-118.0
HD 2701 DR	2.884-215.0	1.194-200.0
HD 3000 DH	2.884-216.0	1.187-116.0
HD 3101 DR	2.884-216.0	1.187-117.0

	Pump kit	Model part no.
<b>HD gas models (continued)</b>		
HD 3500 DB	2.884-217.0	1.810-998.0
HD 3500 DH	2.884-217.0	1.810-997.0
HD 3500 DH-Q/C	2.884-217.0	1.810-996.0
HD 3501	2.884-217.0	1.810-999.0
HD 3600 DH	2.884-217.0	1.180-934.0
HD 800 B	2.883-201.0	1.851-812.0
HD 830 B	2.884-214.0	1.187-103.0
HD 830 B	2.884-214.0	1.187-108.0
HD 1020 B	2.884-016.0	1.810-910.0
HD 1020 B	2.884-016.0	1.810-920.0
HD 1040 B	2.884-084.0	1.810-986.0
<b>HDS electric models</b>		
HDS 2.3/12 C Ed	2.883-891.0	1.170-606.0
HDS 2.3/13 C Ed	2.883-891.0	1.170-605.0
HDS 3.0/20 C Ea	2.883-891.0	1.170-612.0
HDS 4.0/20-4M Ea	2.885-034.0	1.071-408.0
HDS 4.5/22-4M Ea	2.885-034.0	1.071-409.0
HDS 3.5/30-4M Ea	2.885-034.0	1.071-412.0
HDS 3.5/23-4M Eg	2.885-034.0	1.071-407.0
HDS 5.0/30-4S Eb	2.885-033.0	1.071-608.0
HDS 5.0/30-4S Ec	2.885-033.0	1.071-609.0
HDS 801 E (460V)	2.883-446.0	1.030-681.0
HDS 801 E (575V)	2.883-446.0	1.030-701.0
HDS 4.0/20-4M Ea	2.883-913.0	1.027-352.0
HDS 4.5/22-4M Ea	2.883-913.0	1.027-354.0
HDS 4.5/19-4M Ea	2.883-913.0	1.027-357.0
HDS 3.5/30-4M Ea	2.883-913.0	1.027-350.0
HDS 3.5/23-4M Eg	2.883-913.0	1.027-356.0
HDS 5.0/30-4S Eb	2.883-914.0	1.028-341.0
HDS 5.0/30-4S Ec	2.883-914.0	1.028-343.0
HDS NG/LP 4.5/22 Ea ST (vers 1)	2.883-322.0	1.575-715/716.0
HDS NG/LP 4.5/22 Ea ST (vers 2)	2.883-913.0	1.575-715/716.0
HDS NG/LP 3.5/30 Ea ST (vers 1)	2.883-322.0	1.575-719/720.0
HDS NG/LP 3.5/30 Ea ST (vers 2)	2.883-913.0	1.575-719/720.0

	Pump kit	Model part no.
<b>HDS electric models (continued)</b>		
HDS NG/LP 4.5/22 Ea ST (vers 1)	2.883-322.0	1.575-715/716.0
HDS NG/LP 4.5/22 Ea ST (vers 2)	2.883-913.0	1.575-715/716.0
HDS NG/LP 3.5/30 Ea ST (vers 1)	2.883-322.0	1.575-719/720.0
HDS NG/LP 3.5/30 Ea ST (vers 2)	2.883-913.0	1.575-719/720.0
HDS NG/LP 5.0/30 Eb ST (vers 1)	2.883-302.0	1.575-717/718.0
HDS NG/LP 5.0/30 Eb ST (vers 2)	2.883-914.0	1.575-717/718.0
HDS NG/LP 5.0/30 Ec ST (vers 1)	2.883-302.0	1.575-721/722.0
HDS NG/LP 5.0/30 Ec ST (vers 2)	2.883-914.0	1.575-721/722.0
HDS 500 Ci	2.883-459.0	1.890-406.0
HDS 501 C (vers 1)	2.883-883.0	1.272-105.0
HDS 501 C (vers 2)	2.883-827.0	1.272-105.1
HDS 551 C	2.883-890.0	1.169-105.0
HDS 558 C	2.883-891.0	1.170-105.0
HDS 600 Ci	2.883-922.0	1.852-407/408.0
HDS 900 Ci	2.883-855.0	1.873-408/409.0
HDS 745	2.883-322.0	1.026-911.0
HDS 745	2.883-913.0	1.026-344.0
HDS 895 M Eco	2.883-913.0	1.027-515.0
HDS 895 S VEX	2.883-913.0	1.027-304.0
HDS 945	2.883-913.0	1.027-335/336.0
HDS 945	2.883-322.0	1.027-871.0
HDS 945	2.883-322.0	1.027-881.0
HDS 1000	2.883-913.0	1.027-337.0
HDS 1000	2.883-322.0	1.027-851.0
HDS 1000 A	2.880-283.0	1.718-931.0
HDS 1055	2.883-913.0	1.027-38.0/339.0
HDS 1055	2.883-322.0	1.027-81.0/691.0
HDS 1195	2.883-914.0	1.028-332.0
HDS 1195	2.883-302.0	1.028-681.0
HDS 2245 NG/LP	2.883-322.0	1.027-883/884.0
HDS 3005 NG/LP	2.883-302.0	1.028-883/884.0

## KÄRCHER K3 PUMPS



The U-Seals provide better run-dry protection, extend pump life, and allow for inlet water of up to 185°F. Kärcher K3 pumps provide a stronger crankcase with thicker mounting feet and extra-large European made tapered roller bearings for longer pump life. The crankcase is reinforced and comes with the new O-ring seal for leak-free operation. Specially die cast connecting rods provide for quieter operation and longer pump life.



		Order no.	GPM	PSI	HP	RPM	Shaft	Description
<b>KX series</b>								
KX9536R.2 - Right	1	8.920-593.0	9.5	3625	23.8	1740	25 mm	The KX series pump is the patriarch of the Kärcher crankcase pump line; delivering enough volume and pressure for the beefiest of pressure washers. <ul style="list-style-type: none"> <li>• Up to 10.4 GPM and 3,625 PSI</li> <li>• 40.6 oz oil crankcase capacity</li> <li>• 10% Lower RPM than comparable pumps</li> <li>• Increased ceramic thickness</li> </ul>
KX9536L.2 - Left	2	8.920-594.0	9.5	3625	23.8	1740	25 mm	
KX1036R.2 - Right	3	8.920-595.0	10.4	3625	25.8	1740	25 mm	
KX1036L.2 - Left	4	8.920-596.0	10.4	3625	25.8	1740	25 mm	
<b>KX5450 series</b>								
KX5450L - Left	5	8.921-658.0	5.4	5000	18.5	1740	24 mm	The KX5450 series of pumps provide performance up to 5.4 GPM and 5,000 PSI. <ul style="list-style-type: none"> <li>• 40.6 oz oil crankcase capacity</li> <li>• 9' Water Vacuum Head</li> <li>• Oversized connecting rods</li> </ul>
KX5450R - Right	6	8.921-657.0	5.4	5000	18.5	1740	24 mm	
<b>KT series</b>								
KT4540L.2 - Left	7	8.921-715.0	4.5	4000	12.6	1360	25 mm	The KT series of pumps are super-duty pumps that provide the same performance as other pumps but at 10% lower RPMs. <ul style="list-style-type: none"> <li>• 40.6 oz oil crankcase capacity</li> <li>• Oversized connecting rods</li> </ul>
KT4540R.2 - Right	8	8.921-714.0	4.5	4000	12.6	1360	25 mm	
KT6036L.2 - Left	9	8.921-717.0	6.0	3600	15.4	1450	25 mm	
KT6036R.2 - Right	10	8.921-716.0	6.0	3600	15.4	1450	25 mm	
<b>KM series</b>								
KM3540R.3 - Right	11	8.751-186.0	3.5	4000	9.7	1850	24 mm	The third generation of KM pumps are designed for a broad range of applications from 3.5 - 5.6 GPM and up to 4,000 PSI. <ul style="list-style-type: none"> <li>• 23.6 oz oil crankcase capacity</li> <li>• 10% lower RPM than comparable pumps</li> <li>• Heavy-duty tapered roller bearings</li> </ul>
KM4030L.3 - Left	12	8.751-188.0	4.0	3000	8.3	1000	24 mm	
KM4030R.3 - Right	13	8.751-187.0	4.0	3000	8.3	1000	24 mm	
KM4035L.3 - Left	14	8.751-190.0	4.8	3500	11.6	1500	24 mm	
KM4035R.3 - Right	15	8.751-189.0	4.8	3500	11.6	1500	24 mm	
KM5030L.3 - Left	16	8.751-192.0	5.1	3000	10.6	1550	24 mm	
KM5030R.3 - Right	17	8.751-191.0	5.1	3000	10.6	1550	24 mm	
KM6035L.3 - Left	18	8.749-941.0	5.6	3500	13.5	1740	24 mm	
KM6035R.3 - Right	19	8.749-940.0	5.6	3500	13.5	1740	24 mm	



			Order no.	GPM	PSI	HP	RPM	Shaft	Description
<b>KS series</b>									
KS3040G.3	20	8.751-193.0	3.0	4000	10.8	3400	1" hollow	The third generation of KS pumps are designed for a broad range of applications from 3.0 - 5.0 GPM and up to 4,000 PSI for direct drive gas/diesel engine applications. <ul style="list-style-type: none"> <li>• 23.6 oz oil crankcase capacity</li> <li>• Durable ceramic plunger w/mirror finish</li> <li>• Heavy-duty tapered roller bearings</li> </ul>	
KS3540G.3	21	8.751-194.0	3.5	4000	12.6	3400	1" hollow		
KS4040G.3	22	8.751-195.0	4.0	4000	14.3	3400	1" hollow		
KS5030G.3	23	8.751-196.0	5.0	3000	13.4	3400	1" hollow		
<b>KE series</b>									
KE2020F.1	24	9.803-814.0	2.1	2000	3.0	3450	5/8" hollow	The KE series of pumps are hollow shaft pumps designed for direct drive electric units. <ul style="list-style-type: none"> <li>• Up to 3.5 GPM and 2,500 PSI</li> <li>• 14 oz oil crankcase capacity</li> <li>• Set-screw for motor shaft</li> <li>• Durable ceramic pistons w/mirror finished</li> </ul>	
KE2020S.1	25	9.803-815.0	2.1	2000	3.0	1725	5/8" hollow		
KE2825F.1	26	9.803-816.0	2.8	2500	5.0	3450	5/8" hollow		
KE2825S.1	27	8.919-557.0	2.8	2500	5.0	1725	5/8" hollow		
KE3525F.1	28	9.803-818.0	3.5	2500	6.0	3450	3/4" hollow		
<b>KD series</b>									
KD3030R.1	29	9.804-006.0	3.0	3000	6.2	1650	24 mm	The Kärcher KD series of pumps are solid shaft pumps that provide superior performance when compared to similar size pumps. <ul style="list-style-type: none"> <li>• Up to 3.5 GPM and 2,500 PSI</li> <li>• 14 oz oil crankcase capacity</li> <li>• Set-screw for motor shaft</li> <li>• Durable ceramic pistons w/mirror finished</li> </ul>	
KD3025R.1	30	9.803-417.0	3.0	2500	5.2	1180	24 mm		
KD4020R.1	31	9.804-019.0	4.0	2000	5.5	1550	24 mm		
<b>KG Series</b>									
KG2530G.1	32	9.804-033.0	2.5	3000	6.7	3400	3/4"	The Kärcher KG series of pumps are hollow-shaft pumps available in 3/4" and 1" shaft sizes for gas engines. <ul style="list-style-type: none"> <li>• Up to 4.0 GPM and 3,500 PSI</li> <li>• 14 oz oil crankcase capacity</li> <li>• Set-screw for motor shaft</li> <li>• Durable ceramic pistons w/mirror finished</li> </ul>	
KG3030G.1	33	9.803-823.0	3.0	3000	8.1	3400	3/4"		
KG3035G.1	34	9.803-819.0	3.0	3500	9.4	3400	1"		
KG3535G.1	35	9.803-820.0	3.5	3500	11.0	3400	1"		

## K3 PUMP REPAIR KIT SELECTION CHART

Use the selection chart below to find the correct repair kits for the specific Kärcher pump model.

Pump model	Valves	Seal kits	Packing w/ brass	Plunger oil seals	Ceramic plunger kit	Pump rail	Unloader
KM3540	9.802-603.0	9.802-622.0	8.725-359.0	9.802-609.0	9.802-629.0		9.803-900.0
KM3540.2/3	9.802-603.0	8.725-358.0	8.725-359.0	9.802-609.0	8.933-023.0		9.803-900.0
KM4030	9.802-603.0	9.802-619.0	8.725-363.0	9.802-609.0	9.802-620.0		9.803-900.0
KM4030.2/3	9.802-603.0	8.725-362.0	8.725-363.0	9.802-609.0	8.751-238.0		9.803-900.0
KM4035	9.802-603.0	9.802-628.0	8.725-361.0	9.802-609.0	9.802-629.0		9.803-900.0
KM4035.2/3	9.802-603.0	8.725-360.0	8.725-361.0	9.802-609.0	9.802-629.0		9.803-900.0
KM4035H	9.802-603.0	8.725-360.0	8.725-361.0	9.802-609.0	9.802-629.0		9.803-900.0
KM5030	9.802-603.0	9.802-619.0	8.725-363.0	9.802-609.0	9.802-620.0		9.803-900.0
KM5030.2/3	9.802-603.0	8.725-360.0	8.725-363.0	9.802-609.0	8.751-238.0		9.803-900.0
KM6035.2/3	9.802-603.0	8.725-360.0	8.725-361.0	9.802-609.0	8.751-237.0		9.803-900.0
KT4035	9.802-603.0	9.802-605.0	8.916-322.0	9.802-606.0	9.802-607.0		8.715-508.0
KT4035.1	9.802-603.0	8.916-488.0	8.916-322.0	9.802-606.0	9.802-607.0		8.715-508.0
KT4040	9.802-603.0	9.802-605.0	8.916-322.0	9.802-606.0	9.802-607.0		8.715-508.0
KT4040.1	9.802-603.0	8.916-488.0	8.916-322.0	9.802-606.0	9.802-607.0		8.715-508.0
KT5030	9.802-603.0	9.802-610.0	8.916-323.0	9.802-606.0	9.802-611.0		8.715-508.0
KT5030H	9.802-603.0	9.802-631.0	8.916-323.0	9.802-606.0	9.802-611.0		8.715-508.0
KT5030.1	9.802-603.0	8.916-487.0	8.916-323.0	9.802-606.0	9.802-611.0		8.715-508.0
KT6035	9.802-603.0	9.802-605.0	8.916-322.0	9.802-606.0	9.802-607.0		8.715-508.0
KT6035.1	9.802-603.0	8.916-488.0	8.916-322.0	9.802-606.0	9.802-607.0		8.715-508.0
KS3040	9.802-603.0	9.802-622.0	8.725-359.0	9.802-609.0	9.802-621.0		9.803-900.0
KS3040.1	9.802-603.0	8.725-358.0	8.725-359.0	9.802-609.0	8.933-023.0		9.803-900.0
KS3540	9.802-603.0	9.802-622.0	8.725-359.0	9.802-609.0	9.802-621.0		9.803-900.0
KS3540.1	9.802-603.0	8.725-358.0	8.725-359.0	9.802-609.0	8.933-023.0		9.803-900.0
KS4040	9.802-603.0	9.802-622.0	8.725-359.0	9.802-609.0	9.802-621.0		9.803-900.0
KS4040.1	9.802-603.0	8.725-358.0	8.725-359.0	9.802-609.0	8.933-023.0		9.803-900.0
KS5030	9.802-603.0	9.802-622.0	8.725-359.0	9.802-609.0	9.802-621.0		9.803-900.0
KS5030.1	9.802-603.0	8.725-358.0	8.725-359.0	9.802-609.0	8.933-023.0		9.803-900.0
KH5050	9.802-604.0	9.804-492.0	9.804-493.0	9.802-606.0	9.802-629.0	8.717-577.0	8.715-461.0
KX5050	9.802-604.0	9.802-615.0	9.802-616.0	9.802-606.0	9.802-629.0	8.717-577.0	8.715-461.0
KX8030	9.802-608.0	9.802-612.0	8.725-365.0	9.802-606.0	9.802-614.0	8.717-577.0	8.715-508.0
KX8030.1	9.802-608.0	8.725-364.0	8.725-365.0	9.802-606.0	9.802-614.0	8.717-577.0	8.715-508.0
KX1025	9.802-608.0	9.802-612.0	8.725-365.0	9.802-606.0	9.802-614.0	8.717-577.0	8.715-508.0
KX1025.1	9.802-608.0	8.725-364.0	8.725-365.0	9.802-606.0	9.802-614.0	8.717-577.0	8.715-508.0
KX9636.2	8.752-853.0	8.752-844.0	8.752-850.0	8.752-835.0	8.752-839.0	8.717-577.0	8.715-508.0
KX1036.2	8.752-853.0	8.752-844.0	8.752-850.0	8.752-835.0	8.752-839.0	8.717-577.0	8.715-508.0
KE2020F	9.803-936.0	9.803-930.0	8.725-355.0	9.803-937.0	9.803-934.0		9.803-899.0
KE2020F.1	9.803-936.0	8.725-354.0	8.725-355.0	9.803-937.0	9.803-934.0		9.803-899.0
KE2020S	9.803-936.0	9.803-931.0	8.725-357.0	9.803-937.0	9.803-935.0		9.803-899.0
KE2020S.1	9.803-936.0	8.725-356.0	8.725-357.0	9.803-937.0	9.803-935.0		9.803-899.0
KE2825F	9.803-936.0	9.803-930.0	8.725-355.0	9.803-937.0	9.803-934.0		9.803-899.0
KE2825F.1	9.803-936.0	8.725-354.0	8.725-355.0	9.803-937.0	9.803-934.0		9.803-899.0



Pump model	Valves	Seal kits	Packing w/ brass	Plunger oil seals	Ceramic plunger kit	Pump rail	Unloader
KE2825S	9.803-936.0	9.803-931.0	8.725-357.0	9.803-937.0	9.803-935.0		9.803-899.0
KE2825S.1	9.803-936.0	8.725-356.0	8.725-357.0	9.803-937.0	9.803-935.0		9.803-899.0
KE3525F	9.803-936.0	9.803-930.0	8.725-355.0	9.803-937.0	9.803-934.0		9.803-899.0
KE3525F.1	9.803-936.0	8.725-354.0	8.725-355.0	9.803-937.0	9.803-934.0		9.803-899.0
KD3025	9.803-936.0	9.803-931.0	8.725-357.0	9.803-937.0	9.803-935.0	8.717-577.0	9.803-899.0
KD3025.1	9.803-936.0	8.725-356.0	8.725-357.0	9.803-937.0	9.803-935.0	8.717-577.0	9.803-899.0
KD3030	9.803-936.0	9.803-930.0	8.725-355.0	9.803-937.0	9.803-934.0	8.717-577.0	9.803-899.0
KD3030H	9.803-936.0	9.804-076.0	8.725-355.0	9.803-937.0	9.803-934.0	8.717-577.0	9.803-899.0
KD3030.1	9.803-936.0	8.725-354.0	8.725-355.0	9.803-937.0	9.803-934.0	8.717-577.0	9.803-899.0
KD4020	9.803-936.0	9.803-931.0	8.725-357.0	9.803-937.0	9.803-935.0	8.717-577.0	9.803-899.0
KD4020.1	9.803-936.0	8.725-356.0	8.725-357.0	9.803-937.0	9.803-935.0	8.717-577.0	9.803-899.0
KG2530	9.803-936.0	9.803-930.0	8.725-355.0	9.803-937.0	9.803-934.0		9.803-899.0
KG2530.1	9.803-936.0	8.725-354.0	8.725-355.0	9.803-937.0	9.803-934.0		9.803-899.0
KG3030	9.803-936.0	9.803-930.0	8.725-355.0	9.803-937.0	9.803-934.0		9.803-899.0
KG3030.1	9.803-936.0	8.725-354.0	8.725-355.0	9.803-937.0	9.803-934.0		9.803-899.0
KG3035	9.803-936.0	9.803-930.0	8.725-355.0	9.803-937.0	9.803-934.0		9.803-899.0
KG3035.1	9.803-936.0	8.725-354.0	8.725-355.0	9.803-937.0	9.803-934.0		9.803-899.0
KG3535	9.803-936.0	9.803-930.0	8.725-355.0	9.803-937.0	9.803-934.0		9.803-899.0
KG3535.1	9.803-936.0	8.725-354.0	8.725-355.0	9.803-937.0	9.803-934.0		9.803-899.0
KG4030	9.803-936.0	9.803-930.0	8.725-355.0	9.803-937.0	9.803-934.0		9.803-899.0
KG4030.1	9.803-936.0	8.725-354.0	8.725-355.0	9.803-937.0	9.803-934.0		9.803-899.0

## KÄRCHER DIRECT DRIVE PUMP SELECTION CHART

Motor	Engine*	Pump	Unloader	Nozzle	GPM/PSI
9.802-339.0		9.8.3-814.0	9.803-899.0	#3	1.9 / 1500
2HP, 3450rpm		KE2020F.1	VBA35, Direct		
9.804-517.0		9.803-815.0	9.803-899.0	#3	1.9 / 1500
2HP, 1725rpm		KE2020S.1	VBA35, Direct		
9.802-340.0		9.806-816.0	9.803-899.0	#4	2.5 / 1600
3HP, 3450rpm		KE2825F.1	VBA35, Direct		
8.715-090.0		8.919-557.0	9.803-899.0	#4	2.5 / 1600
3HP, 1725rpm		KE2825S.1	VBA35, Direct		
9.802-341.0		9.803-818.0	9.803-899.0	#5	3.5 / 2000
5HP, 3450rpm		KE3525F.1	VBA35, Direct		
		9.804-033.0	9.803-899.0	#3	2.5 / 2700
	6.5HP	KG2530G.1	VBA35, Direct		
		9.803-819.0	9.803-899.0	#3.5	
	9HP	KG3035G.1	VBA35, Direct		
		9.803-819.0	9.803-899.0	#3	2.8 / 3500
	11HP	KG3035G.1	VBA35, Direct		
		9.803-820.0	9.803-899.0	#3.5	3.3 / 3500
	13HP	KG3535G.1	VBA35, Direct		
		8.916-559.0	9.803-899.0	#4.5	3.9 / 3000
	13HP	KG4030G.1	VBA35, Direct		
		8.751-193.0	8.750-299.0	#3	
	13HP	KS3040G.2	VRT3		
		8.751-194.0	9.803-900.0	#4	3.5 / 3000
	11HP	KS3540G.2	VBA35, Direct		
		8.751-195.0	8.750-299.0	#4	
	13HP	KS4040G.2	VRT3		
		8.751-196.0	9.803-900.0	#5.5	4.8 / 3000
	16HP	KS5030G.2	VBA35, Direct		

\*Engine Gross HP as rated by the engine manufacturer

# KÄRCHER K3 PUMP REPAIR KITS



1-5



6-15



26-36

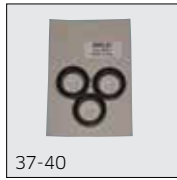

37-40



41-52

Original Factory Direct Repair Kits.

		Order no.
<b>Valve kits</b>		
Valve Kit, KM, KT, KS Series	1	9.802-603.0
Valve Kit, KX5050, KH5050 Series	2	9.802-604.0
Valve Kit, KX8030, KX1025	3	9.802-608.0
Valve Kit, KX9636, KX1036	4	8.752-853.0
Valve Kit, KE, KD, KG Series	5	9.803-936.0
<b>Seal kits - Old-style "V" seals</b>		
Plunger Seals, 15 mm, KS Series, KM3540	6	9.802-622.0
Plunger Seals, 18 mm KM4035	7	9.802-628.0
Plunger Seals, 20 mm, KM4030, KM5030	8	9.802-619.0
Plunger Seals, 20 mm, KT4035, KT4040, KT6035	9	9.802-605.0
Plunger Seals, 22 mm, KT5030	10	9.802-610.0
Plunger Seals, KX5050	11	9.802-615.0
Plunger Seals, 25 mm, KX8030, KX1025	12	9.802-612.0
Plunger Seals, 15 mm, KE2020F, KD3030, KG Series KE2825F, KE3525F	13	9.803-930.0
Plunger Seals, 18 mm, KE2020S, KD3025, KD4020	14	9.803-931.0
Plunger Seals, 15 mm, KD3030H	15	9.804-076.0
<b>New style "U" seals</b>		
Plunger Seals, 15 mm, KS Series, KM3540.2/3	16	8.725-358.0
Plunger Seals, 18 mm KM4035.2/3	17	8.725-360.0
Plunger Seals, 20 mm, KM4030.2/3, KM5030.2/3, KM6035.2/3	18	8.725-362.0
Plunger Seals, 20 mm, KT4035.1, KT4040.1, KT6035.1	19	8.916-488.0
Plunger Seals, 22 mm, KT5030.1	20	8.916-487.0
Plunger Seals, KH5050	21	9.804-492.0
Plunger Seals, 25 mm, KX8030.1, KX1025.1	22	8.725-364.0
Plunger Seals, KX9626.2, KX1036.2	23	8.752-844.0
Plunger Seals, 15 mm, KE2020F.1, KD3030.1, KG.1 Series KE2825F.1, KE3525F.1	24	8.725-354.0
Plunger Seals, 18 mm, KE2020S.1, 025.1, KD4020.1	25	8.725-356.0

		Order no.
<b>Packings with brass (all packing kits with brass include U seals)</b>		
Complete Seal Packing, 15 mm, KS Series, KM3540	26	8.725-359.0
Complete Seal Packing, 15 mm, KE2020F, KD3030, KG Series KE2825F, KE3525F	27	8.725-355.0
Complete Seal Packing, 18 mm, KE2020S, KE2825S, KD Series	28	8.725-357.0
Complete Seal Packing, 18 mm, KM4025, KM4025, KM6035	29	8.725-361.0
Complete Seal Packing, 20 mm, KM4030, KM5030	30	8.725-363.0
Complete Seal Packing, 20 mm, KT Series	31	8.916-322.0
Complete Seal Packing, 22 mm, KT5030	32	8.916-323.0
Complete Seal Packing, KH5050	33	9.804-493.0
Complete Seal Packing, KX5050	34	9.802-616.0
Complete Seal Packing, 25 mm, KX8030, KX1025	35	8.725-365.0
Complete Seal Packing, KX9636, KX1036	36	8.752-850.0
<b>Oil seals</b>		
Plunger Oil Seals, KT, KS, KH, KX5050, KX8030, KX1025 Series	37	9.802-606.0
Plunger Oil Seals, KM, KS Series	38	9.802-609.0
Plunger Oil Seals, KE, KD, KG Series	39	9.803-937.0
Plunger Oil Seals, 22 mm, KX9636.2, KX1036.2	40	8.752-835.0
<b>Ceramic plunger kit (includes bolt, washer, o-ring, teflon ring and ceramic plunger)</b>		
Plunger, 18 mm, KX5050, KH5050, KM3540.1, KM4035.1	41	9.802-629.0
Plunger, 18 mm, KM4035.2/3, KS.3 Series	42	8.933-023.0
Plunger, 20 mm, KM4030, KM5030	43	9.802-620.0
Plunger, 20 mm, KM4030.2/3, KM5030.2/3	44	8.751-238.0
Plunger, KM6035.2/3	45	8.751-237.0
Plunger, 20 mm, KT Series	46	9.802-607.0
Plunger, 22 mm KT5030	47	9.802-611.0
Plunger, 15 mm KS Series	48	9.802-621.0
Plunger, 15 mm KS.1 Series	49	8.933-023.0
Plunger, 25 mm, KX8030, KX1025	50	9.802-614.0
Plunger, 15 mm, KE2020F, KD2825F, KE3525, KD3030, KG Series	51	9.803-934.0
Plunger, 18 mm, KE2020S, KE2825S, KD3025, KD4020	52	9.803-935.0

# KÄRCHER BELT DRIVE PUMP SELECTION CHART

Motor	Engine*	Pump	Eng. Bushing	Mtr. Bushing	Eng/Mtr Pulley	Pump Pulley	Pump Bushing	Unloader	Nozzle	GPM/PSI
		9.804-006.0	9.802-399.0		9.802-384.0	9.802-389.0	9.802-402.0	9.803-899.0	# 3.5	3.0 / 3000
	9HP	kD3030R	H x 1"		2BK 40H	2BK 80H	H x 24 mm	VBA35, Direct		
9.802-341.0		9.804-006.0		9.803-897.0	9.802-371.0	8.715-555.0	9.802-402.0	9.803-899.0	# 3.5	3.0 / 3000
5HP, 3450RPM		kD3030R		H x 3/4"	2AK 32H	2AK 64H	H x 24 mm	VBA35, Direct		
		9.804-019.0	9.803-897.0		9.804-047.0	9.802-375.0	9.802-402.0	9.803-899.0	# 5	3.5 / 2000
	5.5HP	KD4020R.1	H x 3/4"		2AK 34H	2AK 84H	H x 24 mm	VBA35, Direct		
9.802-341.0		9.804-019.0		9.803-897.0	9.803-298.0	9.802-374.0	9.802-402.0	9.803-899.0	# 5	3.5 / 2000
5HP, 3450RPM		KD4020R.1		H x 3/4"	2AK 30H	2AK 74H	H x 24 mm	VBA35, Direct		
9.802-335.0		8.751-187.0		9.802-401.0	9.802-384.0	8.715-591.0	9.802-402.0	9.803-900.0	# 4.5	3.9 / 3000
10HP 3ph, 1760RPM		KM4030R.2		H x 1-3/8"	2BK 40H	2BK 70H	H x 24 mm	VBA35, Direct		
8.709-834.0		8.751-189.0		9.803-980.0	8.715-598.0	8.715-582.0	9.802-402.0	9.803-900.0	# 4	3.7 / 3500
15 HP 3ph, 1760RPM		KM4035R.2		P1 x 1-5/8"	2TB40	2BK 47H	H x 24 mm	VBA35, Direct		
		8.751-189.0	9.802-399.0		8.715-576.0	9.802-390.0	9.802-402.0	9.803-900.0	# 4	3.7 / 3500
	13HP	KM4035R.2	H x 1"		2BK 32H	2BK 90H	H x 24 mm	VBA35, Direct		
9.802-335.0		8.751-191.0		9.802-401.0	9.803-299.0	9.802-388.0	9.802-402.0	9.803-900.0	# 5.5	4.8 / 3000
10HP 3ph, 1760RPM		KM5030R.2		H x 1-3/8"	2BK 57H	2BK 67H	H x 24 mm	VBA35, Direct		
		8.751-191.0	9.802-399.0		9.802-384.0	9.802-390.0	9.802-402.0	9.803-900.0	# 5.5	4.8 / 3000
	16HP	KM5030R.2	H x 1"		2BK 40H	2BK 90H	H x 24 mm	VBA35, Direct		
		8.751-186.0	9.802-399.0		9.802-384.0	9.802-389.0	9.802-402.0	8.750-299.0	# 3	3.0 / 4000
	13HP	KM3540R.2	H x 1"		2BK 40H	2BK 80H	H x 24 mm	VRT3		
		8.789-940.0	9.802-400.0		9.802-382.0	9.802-385.0	9.802-402.0	8.750-299.0	# 6	5.6 / 3500
	24HP	KM6035R.2	H x 1-1/8"		2BK 34H	2BK 70H	H x 24 mm	VRT3		
8.709-834.0		8.745-940.0		8.709-834.0	8.715-598.0	9.802-385.0	9.802-402.0	8.750-299.0	# 6	5.6 / 3500
15 HP 3ph, 1760RPM		KM6035R.2		P1 x 1-5/8"	2TB40	2BK 45H	H x 24 mm	VRT3		
		9.803-400.0	9.802-405.0		9.802-392.0	9.802-395.0	9.802-403.0	8.750-299.0	# 9	7.8 / 3000
	24HP	KX8030R.1	P2 x 1-1/8"		3TB 34	3BK 80H	H x 25 mm	VRT3		
8.730-515.0		9.803-400.0		9.803-980.0	9.802-393.0	9.803-979.0	9.802-403.0	8.750-299.0	# 9	7.8 / 3000
20HP 3ph, 1760RPM		KX8030R.1		P1 x 1-5/8"	3TB 36	3BK 50H	H x 25 mm	VRT3		
		9.803-402.0	9.802-405.0		9.802-393.0	9.802-395.0	9.802-403.0	8.715-508.0	# 14	10.0 / 2000
	20HP	KX1025R.1	P2 x 1-1/8"		3TB 36	3BK 80H	H x 25 mm	VBXL 13gpm		
8.730-515.0		9.803-402.0		9.803-980.0	9.802-393.0	8.715-613.0	9.802-403.0	8.715-508.0	# 14	10.0 / 2000
20HP 3ph, 1760RPM		KX1025R.1		P1 x 1-5/8"	3TB 36	3BK 45H	H x 25 mm	VBXL 13gpm		
		9.803-402.0	9.802-405.0		9.802-393.0	9.802-395.0	9.802-403.0	8.715-508.0	# 13	10.3 / 2500
	24HP	KX1025R.1	P2 x 1-1/8"		3TB 36	3BK 80H	H x 25 mm	VBXL 13gpm		
8.730-515.0		9.804-491.0		9.803-980.0	9.802-394.0	9.803-979.0	9.802-403.0	9.802-360.0	# 5	5.0 / 5000
20HP 3ph, 1760RPM		KH5050R		P1 x 1-5/8"	3TB 40	3BK 50H	H x 25 mm	VB350/4		
		9.804-491.0	9.802-405.0		9.802-394.0	9.802-396.0	9.802-403.0	9.802-360.0	# 5	5.0 / 5000
	24HP	KH5050R	P2 x 1-1/8"		3TB 40	3BK 90H	H x 25 mm	VB350/4		

\*Engine Gross HP as rated by the engine manufacturer

# KÄRCHER PUMP CROSS REFERENCE / COMPARISON CHART



KS Series



KG Series

Kärcher Pumps	Legacy Pumps	General Pumps	AR Pumps
N/A	HG-2425	TH-2520G	XJV2.5G22D-F7
KG2530G.1	HG-2530	TH-3020G	XJV3G22D-F7
N/A	WJG-2521	TP-2520J34	XTV2G22D-F7
N/A	WJG-2525	TP-2526J34	N/A
KG2530G.1	WJG-2530	TP-2530J34	XTV3G22D-F7
N/A	WJG-2535	TP-2533J34	N/A
N/A	WJH-2521-F	TT-2021EBF	XTV2G22E-F8
N/A	WJH-2525-F	TT-2028EBG	N/A
KE2825F.1	WJH-2530-F	N/A	XTV3G22E-F8
KE2020S.1	WJH-2121	T-9051EBF	XTA2G15EBA-F8
N/A	WJH-2132	TT-9111EBF	XTA2G19E-F8
N/A	WMG-2625	TX-1505G6	XMV2.5G26D-F25
KG2530G.1	WMG-2530	TX-1506G6	XMV3G25D-F25
N/A	WMG-2535	N/A	XMV3.5G25D-F25
N/A	WMG-2540	N/A	N/A
KS3040G.3	WMG-3530 (1"H)	TX-1508G8	XMV3G30D-F24
KS3540G.3	WMG-3535 (1"H)	N/A	XMV3.5G30D-F24
KS4040G.3	WMG-3540 (1"H)	TX-1510G8	XMV4G32D-F24
KE2020F.1/KE2825F.1	WMH-2521-F	N/A	XMV2G25E-F33
KE2825F.1	WMH-2230-F	N/A	N/A
KE2825F.1	WMH-2035-F	N/A	N/A
N/A	WMH-1840-F	N/A	N/A
KE3525F.1	WMHS-2035-F (3/4"H)	TT-2035EBF	XMV3.5G25D-F33
KE2020S.1/GE2925S.1	WMH-2021	N/A	XMA2G22E-F33
KE2825S.1	WMH-2525	N/A	XMA2.5G18E-F33
KE2825S.1	WMH-2528	N/A	XMA3G18E-F33
N/A	WMH-2035	N/A	N/A
N/A	WMHS-2035 (3/4"H)	N/A	N/A
KD3025.1	WML-2530	TX-1812S17	XM11.17N
KM4030.3	WML-2534	TX-1812S17	XM13.20N
KM4030.3	WML-2540	TX-1812S17	XM15.15N

Kärcher Pumps	Legacy Pumps	General Pumps	AR Pumps
KG3535G.1	TMG-3535	EZ-4035G34	RKV3.5G40HD-F24
KG54040G.2	TMG-4040	EZ-4040G34	RKV4G40HD-F24
N/A	TMG-4045	EZ-3045G	RKV4.5G40HD-F24
N/A	TMG-4050	N/A	N/A
N/A	TMG-3555	N/A	RKV5.5G40HD-F24
N/A	TMH-3035	EZ-2536E	RKA3.5G30E-F17
N/A	TMH-3040	EZ-2542E	RKA4G30E-F17
N/A	TMH-3050	N/A	N/A
N/A	TMH-3055	N/A	RKA5.5G13E-F17
KM4035.3	TML-3538	TS-1511	RK14.16N
KM4035.3	TML-3045	TS-921	RK14.16N
KM4035.3	TML-3545	N/A	RK14.16N
KM6035.3	TML-3053	TS-2021	RK21.20N
KM6035.3	TMS-3060	N/A	N/A

# KÄRCHER TOOLS



A must for every Service Department. Save time using the right tool for the job.

	Order no.
<b>Kärcher pump tool kit (complete)</b>	9.802-954.0
<b>Pump repair tools</b>	
Oil Seal Bushing Inserter for KT Plunger Rod	9.802-572.0
Oil Seal Piston Inserter for KT Plunger Rod	9.802-578.0
Oil Seal Piston Inserter for KS and KS Plunger Rod	9.802-579.0
Oil Seal Bushing Inserter for KS and KS Plunger Rod	9.802-573.0
Allen Wrench, 8 mm for KT, KX, KH Manifold bolts	9.802-571.0
Allen Wrench, 6 mm for KM, KD, KG, KE, KS Manifold bolts	9.802-567.0
Allen Wrench, 5 mm for Crankcase cover bolts	9.802-570.0
Oil Seal Bushing Inserter for KT, KX, KH Crankshaft	9.802-565.0
Oil Seal Bushing Inserter for KM, KD, KG, KE, KS Crankshaft	9.802-566.0
Piston Seal Extractor	9.802-568.0
Oil Seal Inserter, Piston, KM, KD, KG, KE, KS Pumps	9.802-580.0
Oil Seal Inserter, Guide, KM, KD, KG, KE, KS Pumps	9.802-563.0
Oil Seal Inserter, Piston, KT, KX, KH Pumps	9.802-581.0
Guide, Oil Seal Inserter, KT, KX, KH Pumps	9.802-564.0
Guide, Seal Inserter, Manifold, KD, KE, KG Pumps	8.751-396.0
Guide, Seal Inserter, Manifold KX5050	8.751-404.0
Guide, Seal Inserter, Manifold, KD, KE, KG, KH, KX	8.751-397.0
Guide, Seal Inserter, Manifold, KH KX	8.751-405.0
Screwdriver, Flathead	8.751-403.0
Hammer, Plastic Head	9.802-569.0
Plastic Tool Box	9.802-574.0
<b>Misc. tools</b>	
Valve Seat Wrench	5.901-116.0
General Purpose Valve Pliers	4.901-062.0
Valve Seat Pullers - For use on deep valves	6.815-029.0
O-ring installation Tool for Classic, HD, HDS compact	5.901-090.0
O-ring Installation Tool	5.901-127.0

	Order no.
<b>Misc. tools (cont.)</b>	
Fan Puller	6.815-019.0
Fan Installation Tool	5.901-138.0
Fan Puller - HDS Full-size and upright - 2012	6.816-069.0
Swash Plate Removal Tool	4.901-038.0
Splash Diffuser	4.901-077.0
<b>Test gauges</b>	
Fuel Pressure Gauge	4.901-060.0
Water Temperature Gauge	3.900-003.0
Water Pressure Test Gauge	4.742-025.0
Water Temperature and Volume Gauge	2.901-030.0
Pressure Shut-off Valve	4.580-034.0
<b>Hour meter</b>	
Hour Meter - 24V / 50 mm	6.681-035.0
Hour Meter - 24V / 22 mm	6.681-012.0
<b>Kärcher pump oil</b>	
Single Phase - HD / HDS Classic 15W40	6.288-050.0
Three Phase - HD / HDS Classic 90wt	6.288-016.0
<b>Assembly grease</b>	
Silicone Grease - 5 grams	6.288-088.0
Silicone Grease - 100 grams	6.288-079.0
for Spare Parts / Pumping Kits - 5 grams	6.288-072.0
for Spare Parts / Pumping Kits - 100 grams	6.288-044.0

## COILS



Kärcher's proprietary heating coil is unequalled in the industry for its high heating performance, compact design, and super-efficiency. Double-wall construction – with air passing between the two walls – provides insulation as well as oxygen for the combustion process.

The combustion chamber and heating coil provide even heat distribution with very little condensation or corrosion and 92% + fuel efficiency to conform to the strictest air quality standards.

Combined with other Kärcher advances, our heating coil helps make Kärcher the responsible choice with the lowest cost of operation in the industry.

		<b>Order no.</b>	<b>Description</b>
<b>HDS coils</b>			
	1	4.680-080.0	HDS 1000 BE/DE
	2	4.680-081.0	HDS 4.0/30 Pe Cage; HDS 5.0/32 Pe Cage; HDS 5.5/35 Pe Cage
	3	4.680-129.0	Stainless Steel - HDS 500 Ci
	4	4.680-122.0	HDS 500 Ci
	5	4.680-123.0	HDS 3.5/30-4M Ea; HDS 3.5/23-4M Eg; HDS 4.0/20-4M Ea; HDS 1055
	6	4.680-124.0	HDS 5.0/30-4S Eb/c; HDS 4.5/22-4M Ea; HDS 4.5/19-4M Eg; HDS 1195
	7	4.680-126.0	HDS 3.0/20 C Ea; HDS 501 C; HDS 551 C; HDS 558 C;
	8	4.680-126.0	HDS 2.3/12 C Ed
	9	4.680-127.0	Coil - HDS 801 B; HDS 600 Ci; HDS 900 Ci
	10	4.680-135.0	Coil - HDS 895 S (Tall)
	11	4.680-140.0	Coil - HDS 2.3/13 C Ed; HDS 745; HDS 895 S (short); HDS 945
	12	4.680-144.0	Coil - HDS Middle & Super Class (2012 Forward)
	13	4.680-147.0	Coil - HDS 1000
	14	4.680-154.0	Coil - HDS 1.7/12 U Ed
	15	9.803-135.0	Coil - HDS NG/LPG Units
	16	9.152-371.0	Coil - HDS HDS 2245/3005
<b>Stainless steel coils</b>			
	17	4.680-113.0	HDS 4.5/19-4M Eg; HDS 1195
	18	4.680-114.0	Coil, Stainless Steel - HDS 2.3/13 C Ed; HDS 745; HDS 895 S (short); HDS 945
	20	4.680-129.0	Coil, Stainless Steel - HDS 801 B; HDS 600 Ci; HDS 900 Ci
	21	4.680-130.0	Coil, Stainless Steel - HDS 3.0/20 C Ea; HDS 501 C; HDS 551 C; HDS 558 C
	22	4.680-149.0	Coil, Stainless Steel - HDS Middle & Super Class (2012 Forward)
<b>Liberty series coils</b>			
	23	8.717-928.0	Coil - HDS Heater 5.0/30 Ed
	24	8.919-133.0	Coil - HDS Gas Engine Roll Cage (Subaru); HDS Electric Roll Cage; HDS Electric Hand Truck (small)
	25	9.802-995.0	Coil - HDS Electric Hand Truck (Large)
	26	8.919-136.0	Coil - HDS Gas Engine Roll Cage (Honda); HDS Electric Hand Truck (Medium)
	27	9.803-014.0	Coil - HDS Liberty Series Skids
	28	9.803-135.0	Coil - HDS NG/LPG Units
<b>Cold rolled coils</b>			
Cold-rolled pipe, no weak points from heating to make bends. Heavy-duty schedule 80 carbon steel pipe. "Aluminized steel" wrapper. Best warranty in the industry	29	9.803-014.0	Skid Coil 20" Dia, Sch 80 with Aluminized Steel Wrap, Horizontal
	30	8.919-136.0	DuraCoil 14.5" Dia, Sch 80, HDS Cage, Roll Cage large
	31	8.919-133.0	DuraCoil 14.5" Dia, Sch 80, HDS Electric Roll Cage and Small Gas Cage
	32	9.803-135.0	NG/LPG Coil, 18" Dia

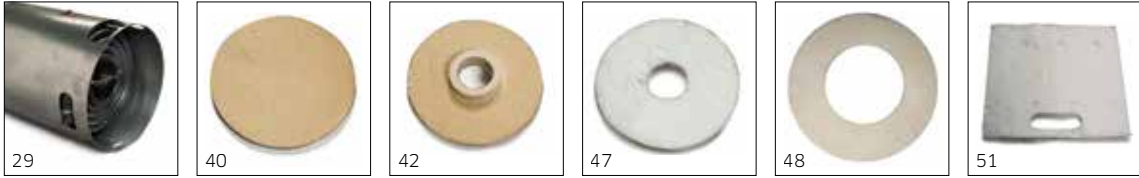

		Order no.	Description
<b>Top and bottom wraps</b>			
	33	8.919-733.0	Coil Wrap, SS, HDS Elec Roll Cage, HDS Small Gas Roll Cage
	34	8.933-031.0	Coil Wrap, SS, HDS Electric Hand Truck, Belt Drive
	35	8.933-028.0	Coil Wrap, SS, Small HDS Electric Hand Truck
	36	8.915-908.0	Coil Wrap, SS, HDS Hand Truck, Direct Drive
	37	9.803-005.0	Top Wrap, SS, HDS Gas/Diesel Skids
	38	9.803-006.0	Bottom Wrap, SS, HDS Gas/Diesel Skids
	39	8.917-568.0	Coil Wrap, SS, NG/LPG Machines
<b>Coil insulation</b>			
Refractory grade ceramic. Retains heat inside coil for better fuel efficiency and paint protection.	40	9.802-883.0	Front Head, No Hole
	41	8.735-002.0	Front Head, No Hole, 16"
	42	9.802-894.0	Burner Head, with Hole
	43	8.731-284.0	Burner Head, with Hole, 16"
	44	8.933-009.0	Gasket, Burner Plate
	45	8.717-424.0	Gasket, Skid Stackless Top
	46	8.717-425.0	Gasket, Stackless Adapter
	47	9.802-900.0	Tank, 1" Blanket, Vertical Oil-Fired Coils
	48	9.802-901.0	Tank, 16" OD x 8" ID, Small Vertical Coils
	49	8.717-410.0	Blanket, w/ Foil sqft (10 sqft rqr)
	50	9.802-896.0	Blanket-No Foil, 24" x 57", Horizontal
	51	9.802-902.0	Blanket-Die Cut, 28" x 24", Horizontal
	52	8.717-433.0	Blanket-Die Cut, 33" x 89" (NG/LPG)
	53	8.930-140.0	Insulation,Tank Head, 20", 10" Opening
	54	9.802-905.0	Insulation Blanket, HDS Hand Truck
	55	8.717-433.0	Insulation Disc, HDS Hand Truck

# KÄRCHER CLEAR-FIRE BURNERS AND REPLACEMENT PARTS



Clear-Fire oil burners by Kärcher are a leader in performance, reliability, and energy efficiency. Industry exclusive features provide a durable, maintenance-free package. Designed especially for the harsh environment of the pressure washer industry, these burners are built to provide years of trouble-free service.

Order no.	Motor/igniter voltage	Motor	Solenoid voltage	Air size	Firing rate Min (GPH)	Firing rate Max (GPH)	Tube length
<b>Horizontal fired burners, Suntec fuel pumps</b>							
8.918-916.0	120V	1/6 HP, 3540 RPM, Continuous-Duty, Split-Phase, Capacitor Start	24V	F22	2	3	3"
8.918-914.0	120V	1/6 HP, 3540 RPM, Continuous-Duty, Split-Phase, Capacitor Start	24V	F12	1.25	2	3"
8.918-913.0	120V	1/6 HP, 3540 RPM, Continuous-Duty, Split-Phase, Capacitor Start	120V	F22	2	3	3"
8.918-915.0	120V	1/6 HP, 3540 RPM, Continuous-Duty, Split-Phase, Capacitor Start	120V	F12	1.25	2	3"
8.918-920.0	120V	1/6 HP, 3540 RPM, Continuous-Duty, Split-Phase, Capacitor Start	120V	F4	0.75	1.25	3"
8.918-917.0	230V	1/6 HP, 3540 RPM, Continuous-Duty, Split-Phase, Capacitor Start	24V	F22	2	3	3"
8.918-918.0	230V	1/6 HP, 3540 RPM, Continuous-Duty, Split-Phase, Capacitor Start	120V	F22	2	3	3"
8.918-919.0	12VDC	1/7 HP, 3450 RPM, Continuous-Duty, Shunt-Wound	12-24V	F22	2	3	3"
<b>Vertical fired burners, Suntec fuel pumps</b>							
8.918-907.0	120V	1/6 HP, 3540 RPM, Continuous-Duty, Split-Phase, Capacitor Start	120V	F6	0.5	3	1"
8.918-908.0	120V	1/6 HP, 3540 RPM, Continuous-Duty, Split-Phase, Capacitor Start	120V	F22	2	3	1"
8.918-909.0	230V	1/6 HP, 3540 RPM, Continuous-Duty, Split-Phase, Capacitor Start	230V	F22	2	3	1"
8.918-912.0	230V	1/6 HP, 3540 RPM, Continuous-Duty, Split-Phase, Capacitor Start	12-24V	F22	2	3	1"
8.918-910.0	12VDC	1/7 HP, 3450 RPM, Continuous-Duty, Shunt-Wound	12-24V	F12	1.25	2	1"
8.918-911.0	12VDC	1/7 HP, 3450 RPM, Continuous-Duty, Shunt-Wound	12-24V	F22	2	3	1"
<b>Vertical fired burners, Danfoss fuel pumps</b>							
8.918-902.0	120V	1/6 HP, 3540 RPM, Continuous-Duty, Split-Phase, Capacitor Start	120V	F22	2	3	1"
8.918-901.0	120V	1/6 HP, 3540 RPM, Continuous-Duty, Split-Phase, Capacitor Start	120V	F6	0.5	3	1"
8.918-903.0	230V	1/6 HP, 3540 RPM, Continuous-Duty, Split-Phase, Capacitor Start	120V	F22	2	3	1"
8.918-904.0	230V	1/6 HP, 3540 RPM, Continuous-Duty, Split-Phase, Capacitor Start	230V	F22	2	3	1"
8.918-905.0	12VDC	1/7 HP, 3450 RPM, Continuous-Duty, Shunt-Wound	12-24V	F12	1.25	2	1"
8.918-911.0	12VDC	1/7 HP, 3450 RPM, Continuous-Duty, Shunt-Wound	12-24V	F22	2	3	1"

Dimension in inches	A	B	C	D	E	F
<b>Horizontal</b>	12.25	3.0	5.75	13.0	3.0	6.0
<b>Vertical (Danfoss)</b>	11.60	3.0	5.10	10.3	3.0	6.0
<b>Vertical (Suntec)</b>	12.25	3.0	5.75	10.3	3.0	6.0

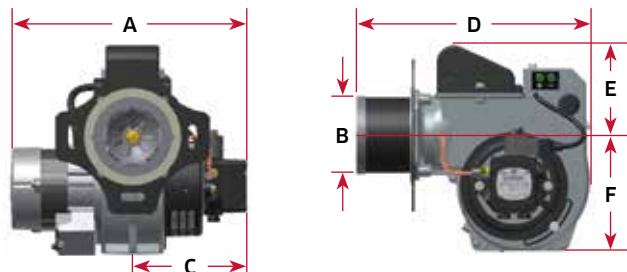



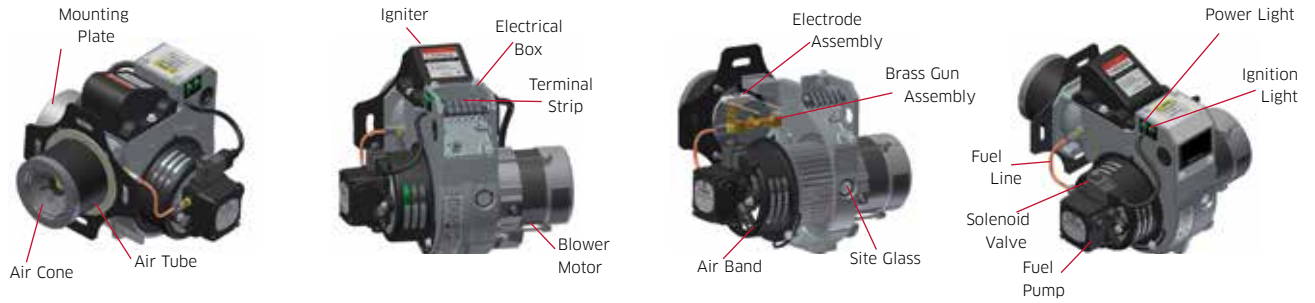

	Order No.	Description
<b>Replacement parts</b>		
	8.700-758.0	Suntec Fuel Pump, 12-24V Sol
	8.700-759.0	Suntec Fuel Pump, 120V Sol
	8.700-760.0	Suntec Fuel Pump, 230V Sol
	8.753-000.0	Danfoss Fuel Pump
	8.750-762.0	Danfoss Solenoid Coil, 230V
	8.750-763.0	Danfoss Solenoid Coil, 120V
	8.750-764.0	Danfoss Solenoid Coil, 12-24V
	8.750-517.0	Burner Motor, 1/6 HP, 115V, 60Hz Emerson
	8.750-518.0	Burner Motor, 1/6 HP, 230V, 60Hz Emerson
	8.751-074.0	Burner Motor, 1/7 HP, 12VDC, Ametek
	8.750-543.0	Flex Coupling, 1/2" x 5/16"
	8.750-073.0	Flex Coupling, 5/16" x 5/16"
	8.750-520.0	Fan, 1/2" Bore
	8.751-072.0	Fan, 5/16" Bore
	8.750-547.0	Connector, 37 Degree Flare, 1/8" NPT, Long
	8.750-545.0	Connector, 37 Degree Flare, 1/8" NPT
	8.749-000.0	Fuel Line Assembly
	8.750-539.0	Gasket, flange
	8.750-526.0	Gun, Electrode / Nozzle, 3"
	8.750-525.0	Gun, Electrode / Nozzle, 1"
	8.750-778.0	Electrode Ignition
	8.919-114.0	Burner Igniter, 120V
	8.919-115.0	Burner Igniter, 230V
	8.919-116.0	Burner Igniter, 12VDC
	8.918-454.0	Junction Box Gasket
	8.750-542.0	Junction Box Cover